

Cohomology of Groups

Jun.-Prof. Dr. Caroline Lassueur
TU Kaiserslautern

Lecture Notes, SS 2018
(4SWS Lecture + 2SWS Exercises)

Version: 20th of July 2018

Foreword	6
Chapter 1. Background Material: Group Theory	7
1 Semi-direct Products	7
2 Presentations of Groups	10
Chapter 2. Background Material: Module Theory	17
3 Modules, Submodules, Morphisms	17
4 Direct Products and Direct Sums	20
5 Exact Sequences	22
6 Free, Injective and Projective Modules	25
7 Tensor Products	27
Chapter 3. Homological Algebra	31
8 Chain and Cochain Complexes	31
9 Projective Resolutions	37
10 Ext and Tor	41
Chapter 4. Cohomology of Groups	48
11 Modules over the Group Algebra	48
12 (Co)homology of Groups	51
13 The Bar Resolution	52
14 Cocycles and Coboundaries	56
Chapter 5. Easy Cohomology	57
15 Low-degree Cohomology	57
16 Cohomology of Cyclic Groups	59
Chapter 6. Cohomology and Group Extensions	62
17 Group Extensions	62
18 H^1 and Group Extensions	65
19 H^2 and Group Extensions	69

Chapter 7. Subgroups and Cohomology	74
20 Restriction in Cohomology	74
21 Transfer in Cohomology	75
22 Induction and Coinduction in Cohomology	77
Chapter 8. Finite Groups	80
23 Cohomology of Finite Groups	80
24 The Theorems of Schur and Zassenhaus	81
25 Burnside’s Transfer Theorem	83
Chapter 8. The Schur Multiplier	86
26 The Schur Multiplier	86
27 The Projective Lifting Property and Universal Central Extensions	87
28 Universal p' -Central Extensions	87
Appendix: The Language of Category Theory	88
A Categories	88
B Functors	90
Bibliography	93
Index of Notation	94
Index	97

This text constitutes a faithful transcript of the lecture **Cohomology of Groups** held at the TU Kaiserslautern during the Summer Semester 2018 (14 Weeks, 4SWS).

Together with the necessary theoretical foundations the main aims of this lecture are to:

- provide students with a modern approach to **group theory**;
- learn about **homological algebra** and a specific **cohomology theory**;
- consistently work with **universal properties** and get acquainted with the **language of category theory**;
- establish connections between the cohomology of groups and the theory of central extensions of groups as developed by Schur at the beginning of the 1900's.

We assume as pre-requisites bachelor-level algebra courses dealing with linear algebra and elementary group theory, such as the standard lectures *Grundlagen der Mathematik*, *Algebraische Strukturen*, *Einführung in die Algebra*, and *Kommutative Algebra* at the TU Kaiserslautern. In order to complement these pre-requisites, the first chapter will deal formally with more advanced background material on group theory, namely semi-direct products and presentation of groups, while the second chapter will provide a short introduction to the theory of modules, where we will emphasise in particular definitions using universal properties but omit proofs.

I am grateful to Jacques Thévenaz who provided me with his lecture "Groupes & Cohomologie" (14 weeks, 2SWS) hold at the EPFL in the Autumn Semester 2011, which I used as a basis for the development of this text, and I am grateful to Rafaël Guglielmetti who provided me with the .tex files of his lecture notes from 2011.

Finally, I am also grateful to the students who mentioned typos in the preliminary versions of these notes. Further comments, corrections and suggestions are of course more than welcome.

Kaiserslautern, 14th July 2018

Chapter 1. Background Material: Group Theory

The aim of this chapter is to introduce formally two constructions of the theory of groups: *semi-direct products* and *presentations of groups*. Later on in the lecture we will relate semi-direct products with a *1st* and a *2nd cohomology group*. Presentations describe groups by generators and relations in a concise way, they will be useful when considering concrete groups, for instance in examples.

References:

- [Hum96] J. F. HUMPHREYS, *A course in group theory*, Oxford Science Publications, The Clarendon Press, Oxford University Press, New York, 1996.
- [Joh90] D. L. JOHNSON, *Presentations of groups*, London Mathematical Society Student Texts, vol. 15, Cambridge University Press, Cambridge, 1990.

1 Semi-direct Products

The semi-direct product is a construction of the theory of groups, which allows us to build new groups from old ones. It is a natural generalisation of the direct product.

Definition 1.1 (*Semi-direct product*)

A group G is said to be the (internal or inner) **semi-direct product** of a normal subgroup $N \trianglelefteq G$ by a subgroup $H \leq G$ if the following conditions hold:

- (a) $G = NH$;
- (b) $N \cap H = \{1\}$.

Notation: $G = N \rtimes H$.

Example 1

- (1) A direct product $G_1 \times G_2$ of two groups is the semi-direct product of $N := G_1 \times \{1\}$ by $H := \{1\} \times G_2$.
- (2) $G = S_3$ is the semi-direct product of $N = C_3 = \langle(1\ 2\ 3)\rangle \trianglelefteq S_3$ and $H = C_2 = \langle(1\ 2)\rangle \leq S_3$. Hence $S_3 \cong C_3 \rtimes C_2$.
Notice that, in particular, a semi-direct product of an abelian subgroup by an abelian subgroup need not be abelian.

(3) More generally $G = S_n$ ($n \geq 3$) is a semi-direct product of $N = A_n \triangleleft S_n$ by $H = C_2 = \langle (1\ 2) \rangle$.

Remark 1.2

(a) If G is a semi-direct product of N by H , then the 2nd Isomorphism Theorem yields

$$G/N = HN/N \cong H/H \cap N = H/\{1\} \cong H$$

and this gives rise to a short exact sequence

$$1 \longrightarrow N \longrightarrow G \longrightarrow H \longrightarrow 1.$$

Hence a semi-direct product of N by H is a special case of an *extension of N by H* .

(b) In a semi-direct product $G = N \rtimes H$ of N by H , the subgroup H acts by conjugation on N , namely $\forall h \in H$,

$$\begin{aligned} \theta_h: N &\longrightarrow N \\ n &\longmapsto hnh^{-1}, \end{aligned}$$

is an automorphism of N . In addition $\theta_{hh'} = \theta_h \circ \theta_{h'}$ for every $h, h' \in H$, so that we have a group homomorphism

$$\begin{aligned} \theta: H &\longrightarrow \text{Aut}(N) \\ h &\longmapsto \theta_h. \end{aligned}$$

Proposition 1.3

With the above notation, N, H and θ are sufficient to reconstruct the group law on G .

Proof: Step 1. Each $g \in G$ can be written in a unique way as $g = nh$ where $n \in N, h \in H$:

indeed by (a) and (b) of the Definition, if $g = nh = n'h'$ with $n, n' \in N, h, h' \in H$, then

$$n^{-1}n' = h(h')^{-1} \in N \cap H = \{1\},$$

hence $n = n'$ and $h = h'$.

Step 2. Group law: Let $g_1 = n_1h_1, g_2 = n_2h_2 \in G$ with $n_1, n_2 \in N, h_1, h_2 \in H$ as above. Then

$$g_1g_2 = n_1h_1n_2h_2 = n_1 \underbrace{h_1n_2(h_1^{-1}h_1)}_{\theta_{h_1}(n_2)} h_2 = [n_1\theta_{h_1}(n_2)] \cdot [h_1h_2].$$

■

With the construction of the group law in the latter proof in mind, we now consider the problem of constructing an "external" (or outer) semi-direct product of groups.

Proposition 1.4

Let N and H be two arbitrary groups, and let $\theta: H \longrightarrow \text{Aut}(N), h \longmapsto \theta_h$ be a group homomorphism. Set $G := N \times H$ as a set. Then the binary operation

$$\begin{aligned} \cdot : G \times G &\longrightarrow G \\ ((n_1, h_1), (n_2, h_2)) &\mapsto (n_1, h_1) \cdot (n_2, h_2) := (n_1 \theta_{h_1}(n_2), h_1 h_2) \end{aligned}$$

defines a group law on G . The neutral element is $1_G = (1_N, 1_H)$ and the inverse of $(n, h) \in N \times H$ is $(n, h)^{-1} = (\theta_{h^{-1}}(n^{-1}), h^{-1})$.

Furthermore G is an internal semi-direct product of $N_0 := N \times \{1\} \cong N$ by $H_0 := \{1\} \times H \cong H$.

Proof: Exercise 1, Exercise Sheet 1. ■

Definition 1.5

In the context of Proposition 1.3 we say that G is the **external (or outer) semi-direct product** of N by H w.r.t. θ , and we write $G = N \rtimes_{\theta} H$.

Example 2

Here are a few examples of very intuitive semi-direct products of groups, which you have very probably already encountered in other lectures, without knowing that they were semi-direct products:

(1) If H acts trivially on N (i.e. $\theta_h = \text{Id}_N \forall h \in H$), then $N \rtimes_{\theta} H = N \times H$.

(2) Let K be a field. Then

$$\text{GL}_n(K) = \text{SL}_n(K) \rtimes \{ \text{diag}(\lambda, 1, \dots, 1) \in \text{GL}_n(K) \mid \lambda \in K^{\times} \},$$

where $\text{diag}(\lambda, 1, \dots, 1)$ is the diagonal matrix with (ordered) diagonal entries $\lambda, 1, \dots, 1$.

(3) Let K be a field and let

$$\begin{aligned} B &:= \left\{ \begin{pmatrix} * & * \\ & \ddots \\ 0 & * \end{pmatrix} \in \text{GL}_n(K) \right\} \quad (= \text{upper triangular matrices}), \\ U &:= \left\{ \begin{pmatrix} 1 & * \\ & \ddots \\ 0 & 1 \end{pmatrix} \in \text{GL}_n(K) \right\} \quad (= \text{upper unitriangular matrices}), \\ T &:= \left\{ \begin{pmatrix} \lambda_1 & & 0 \\ & \ddots & \\ 0 & & \lambda_n \end{pmatrix} \in \text{GL}_n(K) \right\} \quad (= \text{diagonal matrices}). \end{aligned}$$

Then B is a semi-direct product of T by U .

(4) Let $C_m = \langle g \rangle$ and $C_n = \langle h \rangle$ ($m, n \in \mathbb{Z}_{\geq 1}$) be finite cyclic groups.

Assume moreover that $k \in \mathbb{Z}$ is such that $k^n \equiv 1 \pmod{m}$ and set

$$\begin{aligned} \theta : C_n &\longrightarrow \text{Aut}(C_m) \\ h^i &\mapsto (\theta_h)^i, \end{aligned}$$

where $\theta_h : C_m \longrightarrow C_m, g \mapsto g^k$. Then

$$(\theta_h)^n(g) = (\theta_h)^{n-1}(g^k) = (\theta_h)^{n-2}(g^{k^2}) = \dots = g^{k^n} = g$$

since $o(g) = m$ and $k^n \equiv 1 \pmod{m}$. Thus $(\theta_h)^n = \text{Id}_{C_m}$ and θ is a group homomorphism. It follows that under these hypotheses there exists a semi-direct product of C_m by C_n w.r.t. to θ .

Particular case: $m \geq 1, n = 2$ and $k = -1$ yield the dihedral group D_{2m} of order $2m$ with generators g (of order m) and h (of order 2) and the relation $\theta_h(g) = hgh^{-1} = g^{-1}$.

The details of Examples (1)-(4) will be discussed during the Präsenübung on Wednesday, 11th of April.

2 Presentations of Groups

Idea: describe a group using a set of generators and a set of relations between these generators.

- | | | |
|-----------|----------------------------------------------------------------|---------------------------------------------------------------------------------|
| Examples: | (1) $C_m = \langle g \rangle = \langle g \mid g^m = 1 \rangle$ | 1 generator: g
1 relation: $g^m = 1$ |
| | (2) $D_{2m} = C_m \rtimes_{\theta} C_2$ (see Ex. 2(4)) | 2 generators: g, h
3 relations: $g^m = 1, h^2 = 1, hgh^{-1} = g^{-1}$ |
| | (3) $\mathbb{Z} = \langle 1_{\mathbb{Z}} \rangle$ | 1 generator: $1_{\mathbb{Z}}$
no relation (\rightsquigarrow "free group") |

To begin with we examine free groups and generators.

Definition 2.1 (Free group / Universal property of free groups)

Let X be a set. A **free group of basis X** (or **free group on X**) is a group F containing X as a subset and satisfying the following universal property: For any group G and for any (set-theoretic) map $f : X \rightarrow G$, there exists a unique group homomorphism $\tilde{f} : F \rightarrow G$ such that $\tilde{f}|_X = f$, or in other words such that the following diagram commutes:

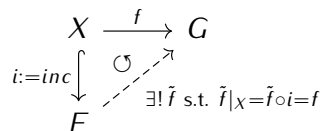

Moreover, $|X|$ is called the **rank** of F .

Proposition 2.2

If F exists, then F is the unique free group of basis X up to a unique isomorphism.

Proof: Assume F' is another free group of basis X .

Let $i : X \hookrightarrow F$ be the canonical inclusion of X in F and let $i' : X \hookrightarrow F'$ be the canonical inclusion of X in F' .

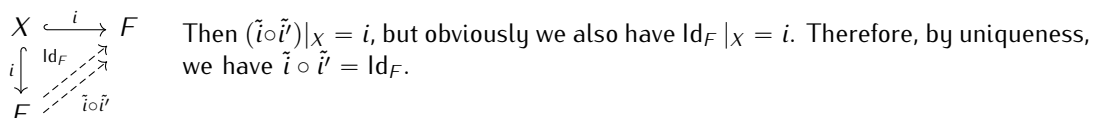
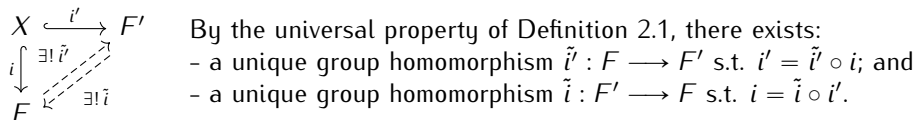

A similar argument yields $\tilde{i}' \circ \tilde{i} = \text{Id}_{F'}$, hence F and F' are isomorphic, up to a unique isomorphism, namely \tilde{i} with inverse \tilde{i}' . ■

Proposition 2.3

If F is a free group of basis X , then X generates F .

Proof: Let $H := \langle X \rangle$ be the subgroup of F generated by X , and let $j_H := X \hookrightarrow H$ denote the canonical inclusion of X in H . By the universal property of Definition 2.1, there exists a unique group homomorphism \tilde{j}_H such that $\tilde{j}_H \circ i = j_H$:

$$\begin{array}{ccc} X & \xrightarrow{j_H} & H \\ \downarrow i & \nearrow \exists! \tilde{j}_H & \uparrow \circlearrowright \\ F & & \end{array}$$

Therefore, letting $\kappa : H \hookrightarrow F$ denote the canonical inclusion of H in F , we have the following commutative diagram:

$$\begin{array}{ccccc} X & \xrightarrow{j_H} & H & \xrightarrow{\kappa} & F \\ \downarrow i & \nearrow \tilde{j}_H & \searrow \text{Id}_F & \nearrow \kappa \circ \tilde{j}_H & \\ F & & & & \end{array}$$

Thus by uniqueness $\kappa \circ \tilde{j}_H = \text{Id}_F$, implying that $\tilde{j}_H : H \rightarrow F$ is injective. Thus

$$F = \text{Im}(\text{Id}_F) = \text{Im}(\kappa \circ \tilde{j}_H) = \text{Im}(\tilde{j}_H) \subseteq H$$

and it follows that $F = H$. The claim follows. ■

Theorem 2.4

For any set X , there exists a free group F with basis X .

Proof: Set $X := \{x_\alpha \mid \alpha \in I\}$ where I is a set in bijection with X , set $Y := \{y_\alpha \mid \alpha \in I\}$ in bijection with X but disjoint from X , i.e. $X \cap Y = \emptyset$, and let $Z := X \cup Y$. Furthermore, set $E := \bigcup_{n=0}^{\infty} Z^n$, where $Z^0 := \{(\)\}$ (i.e. a singleton), $Z^1 := Z$, $Z^2 := Z \times Z, \dots$. Then E becomes a monoid for the concatenation of sequences, that is

$$\underbrace{(z_1, \dots, z_n)}_{\in Z^n} \cdot \underbrace{(z'_1, \dots, z'_m)}_{\in Z^m} := \underbrace{(z_1, \dots, z_n, z'_1, \dots, z'_m)}_{\in Z^{n+m}}.$$

The law \cdot is clearly associative by definition, and the neutral element is the empty sequence $(\) \in Z^0$.

Define the following *Elementary Operations* on the elements of E :

- Type (1): add in a sequence (z_1, \dots, z_n) two consecutive elements x_α, y_α and obtain $(z_1, \dots, z_k, x_\alpha, y_\alpha, z_{k+1}, \dots, z_n)$
- Type (1bis): add in a sequence (z_1, \dots, z_n) two consecutive elements y_α, x_α and obtain $(z_1, \dots, z_m, y_\alpha, x_\alpha, z_{m+1}, \dots, z_n)$
- Type (2): remove from a sequence (z_1, \dots, z_n) two consecutive elements x_α, y_α and obtain $(z_1, \dots, z_r, \check{x}_\alpha, \check{y}_\alpha, z_{r+1}, \dots, z_n)$
- Type (2bis): remove from a sequence (z_1, \dots, z_n) two consecutive elements y_α, x_α and obtain $(z_1, \dots, z_s, \check{y}_\alpha, \check{x}_\alpha, z_{s+1}, \dots, z_n)$

Now define an equivalence relation \sim on E as follows:

two sequences in E are equivalent \iff the 2nd sequence can be obtain from the 1st sequence through a succession of Elementary Operations of type (1), (1bis), (2) and (2bis).

It is indeed easily checked that this relation is:

- reflexive: simply use an empty sequence of Elementary Operations;
- symmetric: since each Elementary Operation is invertible;
- transitive: since 2 consecutive sequences of Elementary Operations is again a sequence of Elementary Operations.

Now set $F := E / \sim$, and write $[z_1, \dots, z_n]$ for the equivalence class of (z_1, \dots, z_n) in $F = E / \sim$.

Claim 1: The above monoid law on E induces a monoid law on F .

The induced law on F is: $[z_1, \dots, z_n] \cdot [z'_1, \dots, z'_m] = [z_1, \dots, z_n, z'_1, \dots, z'_m]$.
 It is well-defined: if $(z_1, \dots, z_n) \sim (t_1, \dots, t_k)$ and $(z'_1, \dots, z'_m) \sim (t'_1, \dots, t'_l)$, then

$$\begin{aligned} (z_1, \dots, z_n) \cdot (z'_1, \dots, z'_m) &= (z_1, \dots, z_n, z'_1, \dots, z'_m) \\ &\sim (t_1, \dots, t_k, z'_1, \dots, z'_m) && \text{via Elementary Operations on the 1st part} \\ &\sim (t_1, \dots, t_k, t'_1, \dots, t'_l) && \text{via Elementary Operations on the 2nd part} \\ &= (t_1, \dots, t_n) \cdot (t'_1, \dots, t'_m) \end{aligned}$$

The associativity is clear, and the neutral element is $[()]$. The claim follows.

Claim 2: F endowed with the monoid law defined in Claim 1 is a group.

Inverses: the inverse of $[z_1, \dots, z_n] \in F$ is the equivalence class of the sequence obtained from (z_1, \dots, z_n) by reversing the order and replacing each x_α with y_α and each y_α with x_α . (Obvious by definition of \sim .)

Claim 3: F is a free group on X .

Let G be a group and $f : X \rightarrow G$ be a map. Define

$$\begin{aligned} \hat{f} : \quad E &\longrightarrow G \\ (z_1, \dots, z_n) &\mapsto f(z_1) \cdot \dots \cdot f(z_n), \end{aligned}$$

where f is defined on Y by $f(y_\alpha) := f(x_\alpha^{-1})$ for every $y_\alpha \in Y$.

Thus, if $(z_1, \dots, z_n) \sim (t_1, \dots, t_k)$, then $\hat{f}(z_1, \dots, z_n) = \hat{f}(t_1, \dots, t_k)$ by definition of f on Y . Hence \hat{f} induces a map

$$\begin{aligned} \tilde{f} : \quad F &\longrightarrow G \\ [z_1, \dots, z_n] &\mapsto f(z_1) \cdot \dots \cdot f(z_n), \end{aligned}$$

By construction \hat{f} is a monoid homomorphism, therefore so is \tilde{f} , but since F and G are groups, \tilde{f} is in fact a group homomorphism. Hence we have a commutative diagram

$$\begin{array}{ccc} X & \xrightarrow{f} & G \\ \downarrow i & \circlearrowleft & \uparrow \tilde{f} \\ F & & \end{array}$$

where $i : X \rightarrow F, x \mapsto [x]$ is the canonical inclusion.

Finally, notice that the definition of \tilde{f} is forced if we want \tilde{f} to be a group homomorphism, hence we have uniqueness of \tilde{f} , and the universal property of Definition 2.1 is satisfied. ■

Notation and Terminology

- To lighten notation, we identify $[x_\alpha] \in F$ with x_α , hence $[y_\alpha]$ with x_α^{-1} , and $[z_1, \dots, z_n]$ with $z_1 \dots z_n$ in F .
- A sequence $(z_1, \dots, z_n) \in E$ with each letter z_i ($1 \leq i \leq n$) equal to an element $x_{\alpha_i} \in X$ or $x_{\alpha_i}^{-1}$ is called a **word** in the generators $\{x_\alpha \mid \alpha \in I\}$. Each word defines an element of F via:

- $(z_1, \dots, z_n) \mapsto z_1 \cdots z_n \in F$. By abuse of language, we then often also call $z_1 \cdots z_n \in F$ a *word*.
- Two words are called **equivalent** $:\iff$ they define the same element of F .
 - If $(z_1, \dots, z_n) \in Z_n \subseteq E$ ($n \in \mathbb{Z}_{\geq 0}$), then n is called the **length** of the word (z_1, \dots, z_n) .
 - A word is said to be **reduced** if it has minimal length amongst all the words which are equivalent to this word.

Proposition 2.5

Every group G is isomorphic to a factor group of a free group.

Proof: Let $S := \{g_\alpha \in G \mid \alpha \in I\}$ be a set of generators for G (in the worst case, take $I = G$). Let $X := \{x_\alpha \mid \alpha \in I\}$ be a set in bijection with S , and let F be the free group on X . Let $i : X \hookrightarrow F$ denote the canonical inclusion.

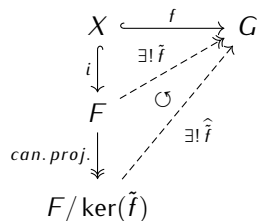

By the universal property of free groups the map $f : X \hookrightarrow G, x_\alpha \mapsto g_\alpha$ induces a unique group homomorphism $\tilde{f} : F \rightarrow G$ such that $\tilde{f} \circ i = f$. Clearly \tilde{f} is surjective since the generators of G are all $\text{Im}(\tilde{f})$. Therefore the 1st Isomorphism Theorem yields $G \cong F/\ker(\tilde{f})$. ■

We can now consider relations between the generators of groups:

Notation and Terminology

Let $S := \{g_\alpha \in G \mid \alpha \in I\}$ be a set of generators for the group G , let $X := \{x_\alpha \mid \alpha \in I\}$ be in bijection with S , and let F be the free group on X .

By the previous proof, $G \cong F/N$, where $N := \ker(\tilde{f})$ ($g_\alpha \leftrightarrow \bar{x}_\alpha = x_\alpha N$ via the homomorphism $\hat{\tilde{f}}$). Any word (z_1, \dots, z_n) in the x_α 's which defines an element of F in N is mapped in G to an expression of the form

$$\bar{z}_1 \cdots \bar{z}_n = 1_G, \quad \text{where } \bar{z}_i := \text{image of } z_i \text{ in } G \text{ under the canonical homomorphism.}$$

In this case, the word (z_1, \dots, z_n) is called a **relation in the group G for the set of generators S** . Now let $R := \{r_\beta \mid \beta \in J\}$ be a set of generators of N as normal subgroup of F (this means that N is generated by the set of all conjugates of R). Such a set R is called a **set of defining relations of G** .

Then the ordered pair (X, R) is called a **presentation** of G , and we write

$$G = \langle X \mid R \rangle = \langle \{x_\alpha\}_{\alpha \in I} \mid \{r_\beta\}_{\beta \in J} \rangle.$$

The group G is said to be **finitely presented** if it admits a presentation $G = \langle X \mid R \rangle$, where both $|X|, |R| < \infty$. In this case, by abuse of notation, we also often write presentations under the form

$$G = \langle x_1, \dots, x_{|X|} \mid r_1 = 1, \dots, r_{|R|} = 1 \rangle.$$

Example 3

The cyclic group $C_n = \{1, g, \dots, g^{n-1}\}$ of order $n \in \mathbb{Z}_{\geq 1}$ generated by $S := \{g\}$. In this case, we have:

$$X = \{x\}$$

$$R = \{x^n\}$$

$$F = \langle x \rangle \cong (C_\infty, \cdot)$$

$C_\infty \xrightarrow{\tilde{f}} C_n, x \mapsto g$ has a kernel generated by x^n as a normal subgroup. Then $C_n = \langle \{x\} \mid \{x^n\} \rangle$.

By abuse of notation, we write simply $C_n = \langle x \mid x^n \rangle$ or also $C_n = \langle x \mid x^n = 1 \rangle$.

Proposition 2.6 (Universal property of presentations)

Let G be a group generated by $S = \{s_\alpha \mid \alpha \in I\}$, isomorphic to a quotient of a free group F on $X = \{x_\alpha \mid \alpha \in I\}$ in bijection with S . Let $R := \{r_\beta \mid \beta \in J\}$ be a set of relations in G .

Then G admits the presentation $G = \langle X \mid R \rangle$ if and only if G satisfies the following universal property:

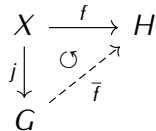

For every group H , and for every set-theoretic map $f : X \rightarrow H$ such that $\tilde{f}(r_\beta) = 1_H \forall r_\beta \in R$, there exists a unique group homomorphism $\bar{f} : G \rightarrow H$ such that $\bar{f} \circ j = f$, where $j : X \rightarrow G, x_\alpha \mapsto s_\alpha$, and \tilde{f} is the unique extension of f to the free group F on X .

Proof: " \Rightarrow ": Suppose that $G = \langle X \mid R \rangle$. Therefore $G \cong F/N$, where N is generated by R as normal subgroup. Thus the condition $\tilde{f}(r_\beta) = 1_H \forall r_\beta \in R$ implies that $N \subseteq \ker(\tilde{f})$, since

$$\tilde{f}(zr_\beta z^{-1}) = \tilde{f}(z) \underbrace{\tilde{f}(r_\beta)}_{=1_H} \tilde{f}(z)^{-1} = 1_H \quad \forall r_\beta \in R, \forall z \in F.$$

Therefore, by the universal property of the quotient, \tilde{f} induces a unique group homomorphism $\bar{f} : G \cong F/N \rightarrow H$ such that $\bar{f} \circ \pi = \tilde{f}$, where $\pi : F \rightarrow F/N$ is the canonical epimorphism. Now, if $i : X \rightarrow F$ denotes the canonical inclusion, then $j = \pi \circ i$, and as a consequence we have $\bar{f} \circ j = f$.

" \Leftarrow ": Conversely, assume that G satisfies the universal property of the statement (i.e. relatively to X, F, R). Set $N := \bar{R}$ for the normal closure of R . Then we have two group homomorphisms:

$$\varphi : \begin{array}{ccc} F/N & \longrightarrow & G \\ \bar{x}_\alpha & \longmapsto & s_\alpha \end{array}$$

induced by $\tilde{f} : F \rightarrow G$, and

$$\psi : \begin{array}{ccc} G & \longrightarrow & F/N \\ s_\alpha & \longmapsto & \bar{x}_\alpha \end{array}$$

given by the universal property. Then clearly $\varphi \circ \psi(s_\alpha) = \varphi(\bar{x}_\alpha) = s_\alpha$ for each $\alpha \in I$, so that $\varphi \circ \psi = \text{Id}_G$ and similarly $\psi \circ \varphi = \text{Id}_{F/N}$. The claim follows. ■

Example 4 (The dihedral groups)

Consider the finite dihedral group D_{2m} of order $2m$ with $2 \leq m < \infty$. We can assume that D_{2m} is generated by

$$r := \text{rotation of angle } \frac{2\pi}{m} \text{ and } s := \text{symmetry through the origin in } \mathbb{R}^2.$$

Then $\langle r \rangle \cong C_m \subseteq G$, $\langle s \rangle \cong C_2$ and we have seen that $D_{2m} = \langle r \rangle \rtimes \langle s \rangle$ with three obvious relations $r^m = 1$, $s^2 = 1$, and $srs^{-1} = r^{-1}$.

Claim: D_{2m} admits the presentation $\langle r, s \mid r^m = 1, s^2 = 1, srs^{-1} = r^{-1} \rangle$.

In order to prove the Claim, we let F be the free group on $X := \{x, y\}$, $R := \{x^m, y^2, yxy^{-1}x\}$, $N \trianglelefteq F$ be the normal subgroup generated by R , and $G := F/N$ so that

$$G = \langle \bar{x}, \bar{y} \mid \bar{x}^m = 1, \bar{y}^2 = 1, \bar{y}\bar{x}\bar{y}^{-1}\bar{x} = 1 \rangle.$$

By the universal property of presentations the map

$$\begin{aligned} f: \{x, y\} &\longrightarrow D_{2m} \\ x &\mapsto r \\ y &\mapsto s \end{aligned}$$

induces a group homomorphism

$$\begin{aligned} \bar{f}: G &\longrightarrow D_{2m} \\ \bar{x} &\mapsto r \\ \bar{y} &\mapsto s, \end{aligned}$$

which is clearly surjective since $D_{2m} = \langle r, s \rangle$. In order to prove that \bar{f} is injective, we prove that G is a group of order at most $2m$. Recall that each element of G is an expression in $\bar{x}, \bar{y}, \bar{x}^{-1}, \bar{y}^{-1}$, hence actually an expression in \bar{x}, \bar{y} , since $\bar{x}^{-1} = \bar{x}^{m-1}$ and $\bar{y}^{-1} = \bar{y}$. Moreover, $\bar{y}\bar{x}\bar{y}^{-1} = \bar{x}^{-1}$ implies $\bar{y}\bar{x} = \bar{x}^{-1}\bar{y}$, hence we are left with expressions of the form

$$\bar{x}^a \bar{y}^b \quad \text{with } 0 \leq a \leq m-1 \text{ and } 0 \leq b \leq 1.$$

Thus we have $|G| \leq 2m$, and it follows that \bar{f} is an isomorphism.

Notice that if we remove the relation $r^m = 1$, we can also formally define an *infinite dihedral group* D_∞ via the following presentation

$$D_\infty := \langle r, s \mid s^2 = 1, srs^{-1} = r^{-1} \rangle.$$

Theorem 2.7

Let G be a group generated by two distinct elements, s and t , both of order 2. Then $G \cong D_{2m}$, where $2 \leq m \leq \infty$. Moreover, m is the order of st in G , and

$$G = \langle s, t \mid s^2 = 1, t^2 = 1, (st)^m = 1 \rangle.$$

($m = \infty$ simply means "no relation".)

Proof: Set $r := st$ and let m be the order of r .

Firstly, note that $m \geq 2$, since $m = 1 \Rightarrow st = 1 \Rightarrow s = t^{-1} = t$ as $t^2 = 1$. Secondly, we have the relation $srs^{-1} = r^{-1}$, since

$$srs^{-1} = \underbrace{s(s^{-1}t)}_{=1_G} s^{-1} = ts^{-1} = t^{-1}s^{-1} = (st)^{-1} = r^{-1}.$$

Clearly G can be generated by r and s as $r = st$ and so $t = sr$.

Now, $H := \langle r \rangle \cong C_m$ and $H \triangleleft G$ since

$$srs^{-1} = r^{-1} \in H \quad \text{and} \quad rrr^{-1} = r \in H \quad (\text{or because } |G : H| = 2).$$

Set $C := \langle s \rangle \cong C_2$.

Claim: $s \notin H$.

Indeed, assuming $s \in H$ yields $s = r^i = (st)^i$ for some $0 \leq i \leq m - 1$. Hence

$$1 = s^2 = s(st)^i = (ts)^{i-1}t = \underbrace{(ts \cdots t)}_{\text{length } i-1} s \underbrace{(ts \cdots t)}_{\text{length } i-1},$$

so that conjugating by t , then s , then \dots , then t , we get $1 = s$, contradicting the assumption that $o(s) = 2$. The claim follows.

Therefore, we have proved that $G = HC$ and $H \cap C = \{1\}$, so that $G = H \rtimes C = D_{2m}$ as seen in the previous section.

Finally, to prove that G admits the presentation $\langle s, t \mid s^2 = 1, t^2 = 1, (st)^m = 1 \rangle$, we apply the universal property of presentations twice to the maps

$$\begin{array}{lcl} f: & \{x_s, x_r\} & \longrightarrow \langle s, t \mid s^2 = 1, t^2 = 1, (st)^m = 1 \rangle \\ & x_s & \mapsto s \\ & x_r & \mapsto st \end{array}$$

and

$$\begin{array}{lcl} g: & \{y_s, y_t\} & \longrightarrow G = \langle r, s \mid r^m = 1, s^2 = 1, srs^{-1} = 1 \rangle \\ & y_s & \mapsto s \\ & y_t & \mapsto sr. \end{array}$$

This yields the existence of two group homomorphisms

$$\bar{f}: G = \langle r, s \mid r^m = 1, s^2 = 1, srs^{-1} = 1 \rangle \longrightarrow \langle s, t \mid s^2 = 1, t^2 = 1, (st)^m = 1 \rangle$$

and

$$\bar{g}: \langle s, t \mid s^2 = 1, t^2 = 1, (st)^m = 1 \rangle \longrightarrow G = \langle r, s \mid r^m = 1, s^2 = 1, srs^{-1} = 1 \rangle$$

such that $\bar{g}\bar{f} = \text{Id}$ and $\bar{f}\bar{g} = \text{Id}$. (Here you should check the details for yourself!) ■

Chapter 2. Background Material: Module Theory

The aim of this chapter is to recall the basics of the theory of modules, which we will use throughout. We review elementary constructions such as quotients, direct sum, direct products, exact sequences, free/projective/injective modules and tensor products, where we emphasise the approach via universal properties. Particularly important for the forthcoming homological algebra and cohomology of groups are the notions of free and, more generally, of projective modules.

Throughout this chapter we let R and S denote rings, and unless otherwise specified, all rings are assumed to be *unital* and *associative*.

Most results are stated without proof, as they have been studied in the B.Sc. lecture *Commutative Algebra*. As further reference I recommend for example:

Reference:

[Rot10] J. J. ROTMAN, *Advanced modern algebra. 2nd ed.*, Providence, RI: American Mathematical Society (AMS), 2010.

3 Modules, Submodules, Morphisms

Definition 3.1 (*Left R -module, right R -module, (R, S) -bimodule, homomorphism of modules*)

- (a) A **left R -module** is an abelian group $(M, +)$ endowed with a **scalar multiplication** (or **external composition law**) $\cdot : R \times M \longrightarrow M$, $(r, m) \mapsto r \cdot m$ such that the map

$$\begin{aligned} \lambda: R &\longrightarrow \text{End}(M) \\ r &\mapsto \lambda(r) := \lambda_r : M \longrightarrow M, m \mapsto r \cdot m, \end{aligned}$$

is a ring homomorphism. By convention, when no confusion is to be made, we will simply write " R -module" to mean "left R -module", and rm instead of $r \cdot m$.

- (a') A **right R -module** is defined analogously using a scalar multiplication $\cdot : M \times R \longrightarrow M$, $(m, r) \mapsto m \cdot r$ on the right-hand side.

- (a'') If S is a second ring, then an **(R, S) -bimodule** is an abelian group $(M, +)$ which is both a left R -module and a right S -module, and which satisfies the axiom

$$r \cdot (m \cdot s) = (r \cdot m) \cdot s \quad \forall r \in R, \forall s \in S, \forall m \in M.$$

- (b) An **R -submodule** of an R -module M is a subgroup $N \leq M$ such that $r \cdot n \in N$ for every $r \in R$ and every $n \in N$. (Similarly for right modules and bimodules.)
- (c) A **(homo)morphism** of R -modules (or an **R -linear map**, or an **R -homomorphism**) is a map of R -modules $\varphi : M \rightarrow N$ such that:
- (i) φ is a group homomorphism; and
 - (ii) $\varphi(r \cdot m) = r \cdot \varphi(m) \quad \forall r \in R, \forall m \in M$.

A bijective homomorphism of R -modules is called an **isomorphism** (or an R -isomorphism), and we write $M \cong N$ if there exists an R -isomorphism between M and N .

An injective (resp. surjective) homomorphism of R -modules is sometimes called a **monomorphism** (resp. **epimorphism**) and we sometimes denote it with a *hook arrow* " \hookrightarrow " (resp. a *two-head arrow* " \twoheadrightarrow ").

(Similarly for right modules and bimodules.)

Notation: We let ${}_R\mathbf{Mod}$ denote the category of left R -modules (with R -linear maps as morphisms), we let \mathbf{Mod}_R denote the category of right R -modules (with R -linear maps as morphisms), and we let ${}_R\mathbf{Mod}_S$ denote the category of (R, S) -bimodules (with (R, S) -linear maps as morphisms). For the language of category theory, see the Appendix.

Convention: From now on, unless otherwise stated, we will always work with left modules.

Example 5

- (a) Vector spaces over a field K are K -modules, and conversely.
- (b) Abelian groups are \mathbb{Z} -modules, and conversely.
- (c) If the ring R is commutative, then any right module can be made into a left module, and conversely.
- (d) If $\varphi : M \rightarrow N$ is a morphism of R -modules, then the kernel $\ker(\varphi)$ of φ is an R -submodule of M and the image $\text{Im}(\varphi) := \varphi(M)$ of φ is an R -submodule of N .

Notation 3.2

Given R -modules M and N , we set $\text{Hom}_R(M, N) := \{\varphi : M \rightarrow N \mid \varphi \text{ is an } R\text{-homomorphism}\}$. This is an abelian group for the pointwise addition of functions:

$$\begin{aligned} + : \quad \text{Hom}_R(M, N) \times \text{Hom}_R(M, N) &\longrightarrow \text{Hom}_R(M, N) \\ (\varphi, \psi) &\longmapsto \varphi + \psi : M \longrightarrow N, m \mapsto \varphi(m) + \psi(m). \end{aligned}$$

In case $N = M$, we write $\text{End}_R(M) := \text{Hom}_R(M, M)$ for the set of endomorphisms of M and $\text{Aut}_R(M)$ for the set of automorphisms of M , i.e. the set of invertible endomorphisms of M .

Exercise [Exercise 1, Exercise Sheet 3]

Let M, N be R -modules. Prove that:

- (a) $\text{End}_R(M)$, endowed with the usual composition and sum of functions, is a ring.
- (b) If R is commutative then the abelian group $\text{Hom}_R(M, N)$ is a left R -module.

Lemma-Definition 3.3 (Quotients of modules)

Let U be an R -submodule of an R -module M . The quotient group M/U can be endowed with the structure of an R -module in a natural way:

$$\begin{aligned} R \times M/U &\longrightarrow M/U \\ (r, m + U) &\longmapsto r \cdot m + U \end{aligned}$$

The canonical map $\pi : M \longrightarrow M/U, m \mapsto m + U$ is R -linear.

Proof: Direct calculation. ■

Theorem 3.4

- (a) **Universal property of the quotient:** Let $\varphi : M \longrightarrow N$ be a homomorphism of R -modules. If U is an R -submodule of M such that $U \subseteq \ker(\varphi)$, then there exists a unique R -module homomorphism $\bar{\varphi} : M/U \longrightarrow N$ such that $\bar{\varphi} \circ \pi = \varphi$, or in other words such that the following diagram commutes:

$$\begin{array}{ccc} M & \xrightarrow{\varphi} & N \\ \pi \downarrow & \circlearrowleft & \uparrow \exists! \bar{\varphi} \\ M/U & & \end{array}$$

Concretely, $\bar{\varphi}(m + U) = \varphi(m) \forall m + U \in M/U$.

- (b) **1st isomorphism theorem:** With the notation of (a), if $U = \ker(\varphi)$, then

$$\bar{\varphi} : M/\ker(\varphi) \longrightarrow \text{Im}(\varphi)$$

is an isomorphism of R -modules.

- (c) **2nd isomorphism theorem:** If U_1, U_2 are R -submodules of M , then so are $U_1 \cap U_2$ and $U_1 + U_2$, and there is an isomorphism of R -modules

$$(U_1 + U_2)/U_2 \cong U_1/U_1 \cap U_2.$$

- (d) **3rd isomorphism theorem:** If $U_1 \subseteq U_2$ are R -submodules of M , then there is an isomorphism of R -modules

$$(M/U_1)/(U_2/U_1) \cong M/U_2.$$

(e) **Correspondence theorem:** If U is an R -submodule of M , then there is a bijection

$$\begin{array}{ccc} \{X \text{ } R\text{-submodule of } M \mid U \subseteq X\} & \longleftrightarrow & \{R\text{-submodules of } M/U\} \\ X & \mapsto & X/U \\ \pi^{-1}(Z) & \longleftarrow & Z. \end{array}$$

Proof: We assume it is known from the "Einführung in die Algebra" that these results hold for abelian groups and morphisms of abelian groups. Exercise: check that they carry over to the R -module structure. ■

Definition 3.5 (Cokernel, coimage)

Let $\varphi \in \text{Hom}_R(M, N)$. Then, the **cokernel** of φ is the quotient R -module $N/\text{Im } \varphi$, and the **coimage** of φ is the quotient R -module $M/\text{ker } \varphi$.

4 Direct Products and Direct Sums

Let $\{M_i\}_{i \in I}$ be a family of R -modules. Then the abelian group $\prod_{i \in I} M_i$, that is the product of $\{M_i\}_{i \in I}$ seen as a family of abelian groups, becomes an R -module via the following external composition law:

$$\begin{aligned} R \times \prod_{i \in I} M_i &\longrightarrow \prod_{i \in I} M_i \\ (r, (m_i)_{i \in I}) &\longmapsto (r \cdot m_i)_{i \in I}. \end{aligned}$$

Furthermore, for each $j \in I$, we let $\pi_j : \prod_{i \in I} M_i \longrightarrow M_j$ denotes the j -th projection from the product to the module M_j .

Proposition 4.1 (Universal property of the direct product)

If $\{\varphi_i : L \longrightarrow M_i\}_{i \in I}$ is a collection of R -linear maps, then there exists a unique morphism of R -modules $\varphi : L \longrightarrow \prod_{i \in I} M_i$ such that $\pi_j \circ \varphi = \varphi_j$ for every $j \in I$.

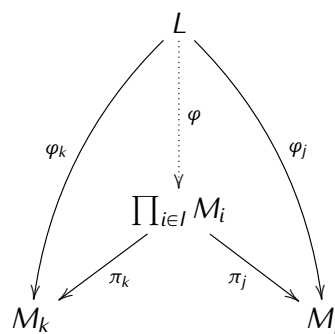

In other words

$$\begin{aligned} \text{Hom}_R \left(L, \prod_{i \in I} M_i \right) &\longrightarrow \prod_{i \in I} \text{Hom}_R(L, M_i) \\ f &\longmapsto (\pi_i \circ f)_i \end{aligned}$$

is an isomorphism of abelian groups.

Proof: Exercise 2, Exercise Sheet 3. ■

Now let $\bigoplus_{i \in I} M_i$ be the subgroup of $\prod_{i \in I} M_i$ consisting of the elements $(m_i)_{i \in I}$ such that $m_i = 0$ almost everywhere (i.e. $m_i = 0$ except for a finite subset of indices $i \in I$). This subgroup is called the **direct sum** of the family $\{M_i\}_{i \in I}$ and is in fact an R -submodule of the product. For each $j \in I$, we let $\eta_j : M_j \rightarrow \bigoplus_{i \in I} M_i$ denote the canonical injection of M_j in the direct sum.

Proposition 4.2 (Universal property of the direct sum)

If $\{f_i : M_i \rightarrow L\}_{i \in I}$ is a collection of R -linear maps, then there exists a unique morphism of R -modules $\varphi : \bigoplus_{i \in I} M_i \rightarrow L$ such that $\varphi \circ \eta_j = f_j$ for every $j \in I$.

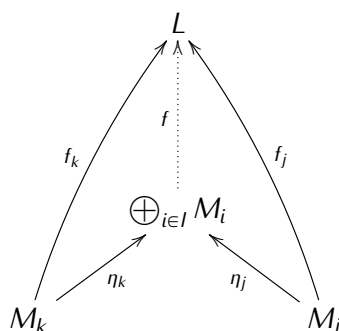

In other words

$$\text{Hom}_R \left(\bigoplus_{i \in I} M_i, L \right) \longrightarrow \prod_{i \in I} \text{Hom}_R(M_i, L)$$

$$f \longmapsto (f \circ \eta_i)_i$$

is an isomorphism of abelian groups.

Proof: Exercise 2, Exercise Sheet 3. ■

Remark 4.3

It is clear that if $|I| < \infty$, then $\bigoplus_{i \in I} M_i = \prod_{i \in I} M_i$.

The direct sum as defined above is often called an *external* direct sum. This relates as follows with the usual notion of *internal* direct sum:

Definition 4.4 (“Internal” direct sums)

Let M be an R -module and N_1, N_2 be two R -submodules of M . We write $M = N_1 \oplus N_2$ if every $m \in M$ can be written in a unique way as $m = n_1 + n_2$, where $n_1 \in N_1$ and $n_2 \in N_2$.

In fact $M = N_1 \oplus N_2$ (internal direct sum) if and only if $M = N_1 + N_2$ and $N_1 \cap N_2 = \{0\}$.

Proposition 4.5

If N_1, N_2 and M are as above and $M = N_1 \oplus N_2$ then the homomorphism of R -modules

$$\varphi : \begin{array}{ccc} M & \longrightarrow & N_1 \times N_2 = N_1 \oplus N_2 \text{ (external direct sum)} \\ m = n_1 + n_2 & \mapsto & (n_1, n_2), \end{array}$$

is an isomorphism of R -modules.

The above generalises to arbitrary internal direct sums $M = \bigoplus_{i \in I} N_i$.

5 Exact Sequences

Definition 5.1 (Exact sequence)

A sequence $L \xrightarrow{\varphi} M \xrightarrow{\psi} N$ of R -modules and R -linear maps is called **exact (at M)** if $\text{Im } \varphi = \text{ker } \psi$.

Remark 5.2 (Injectivity/surjectivity/short exact sequences)

(a) $L \xrightarrow{\varphi} M$ is injective $\iff 0 \longrightarrow L \xrightarrow{\varphi} M$ is exact at L .

(b) $M \xrightarrow{\psi} N$ is surjective $\iff M \xrightarrow{\psi} N \longrightarrow 0$ is exact at N .

(c) $0 \longrightarrow L \xrightarrow{\varphi} M \xrightarrow{\psi} N \longrightarrow 0$ is exact (i.e. at L , M and N) if and only if φ is injective, ψ is surjective and ψ induces an isomorphism $\bar{\psi} : M/\text{Im } \varphi \longrightarrow N$.

Such a sequence is called a **short exact sequence** (s.e.s. in short).

(d) If $\varphi \in \text{Hom}_R(L, M)$ is an injective morphism, then there is a s.e.s.

$$0 \longrightarrow L \xrightarrow{\varphi} M \xrightarrow{\pi} \text{coker}(\varphi) \longrightarrow 0$$

where π is the canonical projection.

(d) If $\psi \in \text{Hom}_R(M, N)$ is a surjective morphism, then there is a s.e.s.

$$0 \longrightarrow \text{ker}(\psi) \xrightarrow{i} M \xrightarrow{\psi} N \longrightarrow 0,$$

where i is the canonical injection.

Proposition 5.3

Let Q be an R -module. Then the following holds:

(a) $\text{Hom}_R(Q, -) : {}_R\mathbf{Mod} \longrightarrow \mathbf{Ab}$ is a *left* exact covariant functor. In other words, if $0 \longrightarrow L \xrightarrow{\varphi} M \xrightarrow{\psi} N \longrightarrow 0$ is a s.e.s of R -modules, then the induced sequence

$$0 \longrightarrow \text{Hom}_R(Q, L) \xrightarrow{\varphi_*} \text{Hom}_R(Q, M) \xrightarrow{\psi_*} \text{Hom}_R(Q, N)$$

is an exact sequence of abelian groups. (Here $\varphi_* := \text{Hom}_R(Q, \varphi)$, that is $\varphi_*(\alpha) = \varphi \circ \alpha$ and similarly for ψ_* .)

(b) $\text{Hom}_R(-, Q) : {}_R\mathbf{Mod} \longrightarrow \mathbf{Ab}$ is a *left* exact contravariant functor. In other words, if $0 \longrightarrow L \xrightarrow{\varphi} M \xrightarrow{\psi} N \longrightarrow 0$ is a s.e.s of R -modules, then the induced sequence

$$0 \longrightarrow \text{Hom}_R(N, Q) \xrightarrow{\psi^*} \text{Hom}_R(M, Q) \xrightarrow{\varphi^*} \text{Hom}_R(L, Q)$$

is an exact sequence of abelian groups. (Here $\varphi^* := \text{Hom}_R(\varphi, Q)$, that is $\varphi^*(\alpha) = \alpha \circ \varphi$ and similarly for ψ^* .)

Proof: One easily checks that $\text{Hom}_R(Q, -)$ and $\text{Hom}_R(-, Q)$ are functors.

- (a) · **Exactness at $\text{Hom}_R(Q, L)$:** Clear.
- **Exactness at $\text{Hom}_R(Q, M)$:** We have

$$\begin{aligned} \beta \in \ker \psi_* &\iff \psi \circ \beta = 0 \\ &\iff \text{Im } \beta \subset \ker \psi \\ &\iff \text{Im } \beta \subset \text{Im } \varphi \\ &\iff \forall q \in Q, \exists! l_q \in L \text{ such that } \beta(q) = \varphi(l_q) \\ &\iff \exists \text{ a map } \lambda : Q \longrightarrow L \text{ which sends } q \text{ to } l_q \text{ and such that } \varphi \circ \lambda = \beta \\ &\stackrel{\varphi \text{ inj}}{\iff} \exists \lambda \in \text{Hom}_R(Q, L) \text{ which send } q \text{ to } l_q \text{ and such that } \varphi \circ \lambda = \beta \\ &\iff \beta \in \text{Im } \varphi_*. \end{aligned}$$

- (b) Exercise 5, Exercise Sheet 3. ■

Remark 5.4

Notice that $\text{Hom}_R(Q, -)$ and $\text{Hom}_R(-, Q)$ are not *right* exact in general. See Exercise 5, Exercise Sheet 3.

Lemma 5.5 (The snake lemma)

Suppose we are given the following commutative diagram of R -modules and R -module homomorphisms with exact rows:

$$\begin{array}{ccccccccc} L & \xrightarrow{\varphi} & M & \xrightarrow{\psi} & N & \longrightarrow & 0 \\ & & \downarrow f & & \downarrow g & & \downarrow h \\ 0 & \longrightarrow & L' & \xrightarrow{\varphi'} & M' & \xrightarrow{\psi'} & N' \end{array}$$

Then the following hold:

- (a) There exists an exact sequence

$$\ker f \xrightarrow{\varphi} \ker g \xrightarrow{\psi} \ker h \xrightarrow{\delta} \text{coker } f \xrightarrow{\overline{\varphi'}} \text{coker } g \xrightarrow{\overline{\psi'}} \text{coker } h,$$

where $\overline{\varphi'}$, $\overline{\psi'}$ are the morphisms induced by the universal property of the quotient, and $\delta(n) = \pi_L \circ \varphi'^{-1} \circ g \circ \psi^{-1}(n)$ for every $n \in \ker(h)$ (here $\pi_L : L \longrightarrow \text{coker}(f)$ is the canonical homomorphism). The map δ is called the **connecting homomorphism**.

- (b) If $\varphi : L \longrightarrow M$ is injective, then $\varphi|_{\ker f} : \ker f \longrightarrow \ker g$ is injective.
- (c) If $\psi' : M' \longrightarrow N'$ is surjective, then $\overline{\psi'} : \text{coker } g \longrightarrow \text{coker } h$ is surjective.

Proof: (a) First, we check that δ is well-defined. Let $n \in \ker h$ and choose two preimages $m_1, m_2 \in M$ of n under ψ . Hence $m_1 - m_2 \in \ker \psi = \text{Im } \varphi$. Thus, there exists $l \in L$ such that $m_1 = \varphi(l) + m_2$. Then, we have

$$g(m_1) = g \circ \varphi(l) + g(m_2) = \varphi' \circ f(l) + g(m_2).$$

Since $n \in \ker h$, for $i \in \{1, 2\}$ we have

$$\psi' \circ g(m_i) = h \circ \psi(m_i) = h(n) = 0,$$

so that $g(m_i) \in \ker \psi' = \text{Im } \varphi'$. Therefore, there exists $l'_i \in L'$ such that $\varphi'(l'_i) = g(m_i)$. It follows that

$$g(m_2) = \varphi'(l'_2) = \varphi' \circ f(l) + \varphi'(l'_1).$$

Since φ' is injective, we obtain $l'_2 = f(l) + l'_1$. Hence, l'_1 and l'_2 have the same image in $\text{coker } f$. Therefore, δ is well-defined.

We now want to check the exactness at $\ker h$. Let $m \in \ker g$. Then $g(m) = 0$, so that $\delta\psi(m) = 0$ and thus $\text{Im } \psi|_{\ker h} \subset \ker \delta$. Conversely, let $m \in \ker \delta$. With the previous notation, this means that $\bar{l}'_1 = 0$, and thus $l'_1 = f(\tilde{l})$ for some $\tilde{l} \in L$. We have

$$g \circ \varphi(\tilde{l}) = \varphi' \circ f(\tilde{l}) = \varphi'(l'_1) = g(m_1).$$

Hence, $m_1 - \varphi(\tilde{l}) \in \ker g$. It remains to check that this element is sent to n by ψ . We get

$$\psi(m_1 - \varphi(\tilde{l})) = \psi(m_1) - \psi \circ \varphi(\tilde{l}) = \psi(m_1) = n.$$

Hence $\text{Im } \psi|_{\ker h} = \ker \delta$.

The fact that δ is an R -homomorphism, and the exactness at the other points are checked in a similar fashion.

(b) Is obvious.

(c) Is a direct consequence of the universal property of the quotient. ■

Remark 5.6

The name of the lemma comes from the following diagram

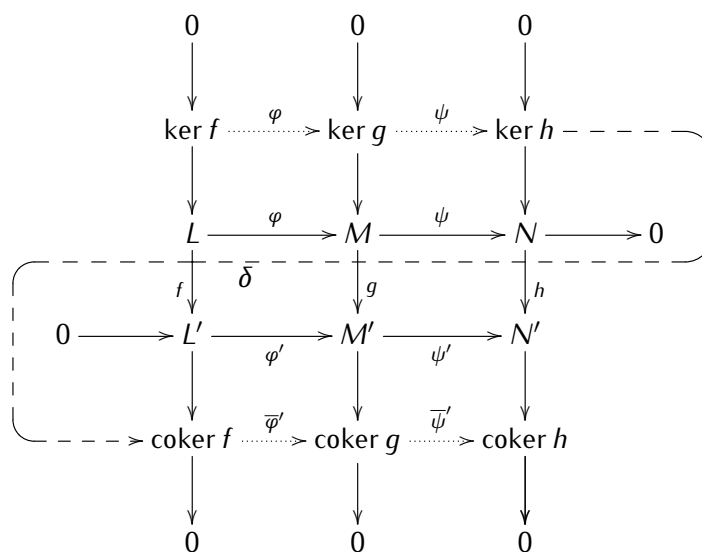

If fact the snake lemma holds in any abelian category. In particular, it holds for the categories of chain and cochain complexes, which we will study in Chapter 3.

Lemma-Definition 5.7

A s.e.s. $0 \rightarrow L \xrightarrow{\varphi} M \xrightarrow{\psi} N \rightarrow 0$ of R -modules is called **split** iff it satisfies the following equivalent conditions:

- (a) There exists an R -linear map $\sigma : N \rightarrow M$ such that $\psi \circ \sigma = \text{id}_N$ (σ is called a **section** for ψ).
- (b) There exists an R -linear map $\rho : M \rightarrow L$ such that $\rho \circ \varphi = \text{id}_L$ (ρ is called a **retraction** for φ).

- (c) The submodule $\text{Im } \varphi = \ker \psi$ is a *direct summand* of M , that is there exists a submodule M' of M such that $M = \text{Im } \varphi \oplus M'$.

Proof: Exercise. ■

Example 6

The sequence

$$0 \longrightarrow \mathbb{Z}/2\mathbb{Z} \xrightarrow{\varphi} \mathbb{Z}/2\mathbb{Z} \oplus \mathbb{Z}/2\mathbb{Z} \xrightarrow{\pi} \mathbb{Z}/2\mathbb{Z} \longrightarrow 0$$

defined by $\varphi([1]) = ([1], [0])$ and π is the canonical projection into the cokernel of φ is split but the sequence

$$0 \longrightarrow \mathbb{Z}/2\mathbb{Z} \xrightarrow{\varphi} \mathbb{Z}/4\mathbb{Z} \xrightarrow{\pi} \mathbb{Z}/2\mathbb{Z} \longrightarrow 0$$

defined by $\varphi([1]) = ([2])$ and π is the canonical projection onto the cokernel of φ is not split.

6 Free, Injective and Projective Modules

Free modules

Definition 6.1 (Generating set / R -basis / free R -module)

Let M be an R -module and $X \subseteq M$ be a subset.

- M is said to be **generated** by X if every element of M can be written as an R -linear combination $\sum_{x \in X} \lambda_x X$, that is with $\lambda_x \in R$ almost everywhere 0.
- X is an **R -basis** (or a **basis**) if X generates M and if every element of M can be written *in a unique way* as an R -linear combination $\sum_{x \in X} \lambda_x X$ (i.e. with $\lambda_s \in R$ almost everywhere 0).
- M is called **free** if it admits an R -basis.

Notation: In this case we write $M = \bigoplus_{x \in X} Rx \cong \bigoplus_{x \in X} R =: R^{(X)}$.

Remark 6.2

- When we write the sum $\sum_{x \in X} \lambda_x X$, we always assume that the λ_s are 0 almost everywhere.
- Let X be a generating set for M . Then, X is a basis of M if and only if S is R -linearly independent.
- If R is a field, then every R -module is free. (R -vector spaces.)

Proposition 6.3 (Universal property of free modules)

Let P be a free R -module with basis X and let $i : X \hookrightarrow P$ be the inclusion map. For every R -module M and for every map (of sets) $\varphi : X \rightarrow M$, there exists a unique morphism of R -modules

$\tilde{\varphi} : P \rightarrow M$ such that the following diagram commutes

$$\begin{array}{ccc} X & \xrightarrow{\varphi} & M \\ \downarrow i & \nearrow \tilde{\varphi} & \\ P & & \end{array}$$

Proof: If $P \ni m = \sum_{x \in X} \lambda_x x$ (unique expression), then we set $\tilde{\varphi}(m) = \sum_{x \in X} \lambda_x \varphi(x)$. It is then easy to check $\tilde{\varphi}$ has the required properties. ■

Proposition 6.4 (Properties of free modules)

- (a) Every R -module M is isomorphic to a quotient of a free R -module.
- (b) If P is a free R -module, then $\text{Hom}_R(P, -)$ is an exact functor.

Proof: (a) Choose a set $\{x_i\}_{i \in I}$ of generators of M (take all elements of M if necessary). Then define

$$\begin{aligned} \varphi : \bigoplus_{i \in I} R &\rightarrow M \\ (r_i)_{i \in I} &\mapsto \sum_{i \in I} r_i x_i. \end{aligned}$$

It follows that $M \cong (\bigoplus_{i \in I} R) / \ker \varphi$.

- (b) We know that $\text{Hom}(P, -)$ is left exact for any R -module P . It remains to prove that if $\psi : M \rightarrow N$ is a surjective R -linear maps, then $\psi_* : \text{Hom}_R(P, M) \rightarrow \text{Hom}_R(P, N) : \beta \mapsto \psi_*(\beta) = \psi \circ \beta$ is also surjective. So let $\alpha \in \text{Hom}_R(P, N)$. We have the following situation:

$$\begin{array}{ccccc} & & P & & \\ & \nearrow \exists? & \downarrow \alpha & & \\ M & \xrightarrow{\psi} & N & \longrightarrow & 0 \end{array}$$

Let $\{e_i\}_{i \in I}$ be an R -basis of P . Each $\alpha(e_i) \in N$ is in the image of ψ , so that for each $i \in I$ there exists $m_i \in M$ such that $\psi(m_i) = \alpha(e_i)$. Hence, there is a map $\tilde{\beta} : \{e_i\}_{i \in I} \rightarrow M, e_i \mapsto m_i$. By the universal property of free modules this induces an R -linear map $\tilde{\beta} : P \rightarrow M$ such that $\tilde{\beta}(e_i) = m_i \forall i \in I$. Thus

$$\psi \circ \tilde{\beta}(e_i) = \psi(m_i) = \alpha(e_i),$$

so that $\psi \circ \tilde{\beta}$ and α coincide on the basis $\{e_i\}_{i \in I}$. By the uniqueness of $\tilde{\beta}$, we must have $\alpha = \psi \circ \tilde{\beta} = \psi_*(\tilde{\beta})$. ■

Injective modules

Proposition-Definition 6.5 (Injective module)

Let I be an R -module. Then the following are equivalent:

- (a) The functor $\text{Hom}_R(-, I)$ is exact.

- (b) If $\varphi \in \text{Hom}_R(L, M)$ is an injective morphism, then $\varphi_* : \text{Hom}_R(M, I) \rightarrow \text{Hom}_R(L, I)$ is surjective (hence, any R -linear map $\alpha : L \rightarrow I$ can be lifted to an R -linear map $\beta : M \rightarrow I$, i.e., $\beta \circ \varphi = \alpha$).
- (c) If $\eta : I \rightarrow M$ is an injective R -linear map, then η splits, i.e., there exists $\rho : M \rightarrow I$ such that $\rho \circ \eta = \text{Id}_I$.

If I satisfies these equivalent conditions, then I is called **injective**.

Proof: Exercise. ■

Remark 6.6

Note that Condition (b) is particularly interesting when $L \leq M$ and φ is the inclusion.

Projective modules

Proposition-Definition 6.7 (*Projective module*)

Let P be an R -module. Then the following are equivalent:

- (a) The functor $\text{Hom}_R(P, -)$ is exact.
- (b) If $\psi \in \text{Hom}_R(M, N)$ is a surjective morphism of R -modules, then the morphism of abelian groups $\psi_* : \text{Hom}_R(P, M) \rightarrow \text{Hom}_R(P, N)$ is surjective.
- (c) If $\pi : M \rightarrow P$ is a surjective R -linear map, then π splits, i.e., there exists $\sigma : P \rightarrow M$ such that $\pi \circ \sigma = \text{Id}_P$.
- (d) P is isomorphic to a direct summand of a free R -module.

If P satisfies these equivalent conditions, then P is called **projective**.

Example 7

- (a) If $R = \mathbb{Z}$, then every submodule of a free \mathbb{Z} -module is again free (main theorem on \mathbb{Z} -modules).
- (b) Let e be an idempotent in R , that is $e^2 = e$. Then, $R \cong Re \oplus R(1 - e)$ and Re is projective but not free if $e \neq 0, 1$.
- (c) A product of modules $\{I_j\}_{j \in J}$ is injective if and only if each I_j is injective.
- (d) A direct sum of modules $\{P_i\}_{i \in I}$ is projective if and only if each P_i is projective.

7 Tensor Products

Definition 7.1 (*Tensor product of R -modules*)

Let M be a right R -module and let N be a left R -module. Let F be the free abelian group (= free

\mathbb{Z} -module) with basis $M \times N$. Let G be the subgroup of F generated by all the elements

$$\begin{aligned} (m_1 + m_2, n) - (m_1, n) - (m_2, n), \quad \forall m_1, m_2 \in M, \forall n \in N, \\ (m, n_1 + n_2) - (m, n_1) - (m, n_2), \quad \forall m \in M, \forall n_1, n_2 \in N, \text{ and} \\ (mr, n) - (m, rn), \quad \forall m \in M, \forall n \in N, \forall r \in R. \end{aligned}$$

The **tensor product of M and N (balanced over R)**, is the abelian group $M \otimes_R N := F/G$. The class of $(m, n) \in F$ in $M \otimes_R N$ is denoted by $m \otimes n$.

Remark 7.2

(a) $M \otimes_R N = \langle m \otimes n \mid m \in M, n \in N \rangle_{\mathbb{Z}}$.

(b) In $M \otimes_R N$, we have the relations

$$\begin{aligned} (m_1 + m_2) \otimes n &= m_1 \otimes n + m_2 \otimes n, \quad \forall m_1, m_2 \in M, \forall n \in N, \\ m \otimes (n_1 + n_2) &= m \otimes n_1 + m \otimes n_2, \quad \forall m \in M, \forall n_1, n_2 \in N, \text{ and} \\ mr \otimes n &= m \otimes rn, \quad \forall m \in M, \forall n \in N, \forall r \in R. \end{aligned}$$

In particular, $m \otimes 0 = 0 = 0 \otimes n \quad \forall m \in M, \forall n \in N$ and $(-m) \otimes n = -(m \otimes n) = m \otimes (-n) \quad \forall m \in M, \forall n \in N$.

Definition 7.3 (R -balanced map)

Let M and N be as above and let A be an abelian group. A map $f : M \times N \rightarrow A$ is called **R -balanced** if

$$\begin{aligned} f(m_1 + m_2, n) &= f(m_1, n) + f(m_2, n), \quad \forall m_1, m_2 \in M, \forall n \in N, \\ f(m, n_1 + n_2) &= f(m, n_1) + f(m, n_2), \quad \forall m \in M, \forall n_1, n_2 \in N, \\ f(mr, n) &= f(m, rn), \quad \forall m \in M, \forall n \in N, \forall r \in R. \end{aligned}$$

Remark 7.4

The canonical map $t : M \times N \rightarrow M \otimes_R N, (m, n) \mapsto m \otimes n$ is R -balanced.

Proposition 7.5 (Universal property of the tensor product)

Let M be a right R -module and let N be a left R -module. For every abelian group A and every R -balanced map $f : M \times N \rightarrow A$ there exists a unique \mathbb{Z} -linear map $\bar{f} : M \otimes_R N \rightarrow A$ such that the following diagram commutes:

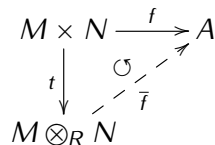

Proof: Let $\iota : M \times N \rightarrow F$ denote the canonical inclusion, and let $\pi : F \rightarrow F/G$ denote the canonical projection. By the universal property of the free \mathbb{Z} -module, there exists a unique \mathbb{Z} -linear map $\tilde{f} : F \rightarrow A$ such that $\tilde{f} \circ \iota = f$. Since f is R -balanced, we have that $G \subseteq \ker(\tilde{f})$. Therefore, the universal property of the quotient yields the existence of a unique homomorphism of abelian groups $\bar{f} : F/G \rightarrow A$ such that

$\bar{f} \circ \pi = \tilde{f}$:

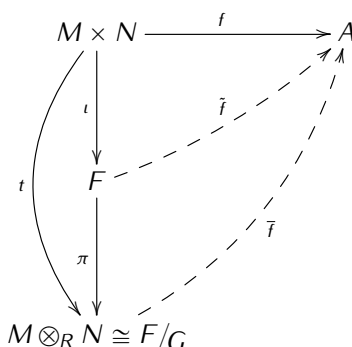

Clearly $t = \pi \circ l$, and hence $\bar{f} \circ t = \bar{f} \circ \pi \circ l = \tilde{f} \circ l = f$. ■

Remark 7.6

- (a) Let $\{M_i\}_{i \in I}$ be a collection of right R -modules, M be a right R -module, N be a left R -module and $\{N_j\}_{j \in J}$ be a collection of left R -modules. Then, we have

$$\bigoplus_{i \in I} M_i \otimes_R N \cong \bigoplus_{i \in I} (M_i \otimes_R N)$$

$$M \otimes_R \bigoplus_{j \in J} N_j \cong \bigoplus_{j \in J} (M \otimes_R N_j).$$

- (b) For every R -module M , we have $R \otimes_R M \cong M$ via $r \otimes m \mapsto rm$.
- (c) If P be a free left R -module with basis X , then $M \otimes_R P \cong \bigoplus_{x \in X} M$.
- (d) Let Q be a ring. Let M be a (Q, R) -bimodule and let N be an (R, S) -module. Then $M \otimes_R N$ can be endowed with the structure of a (Q, S) -bimodule via

$$q(m \otimes n)s = qm \otimes ns, \quad \forall q \in Q, \forall s \in S, \forall m \in M, \forall n \in N.$$

- (e) If R is commutative, then any R -module can be viewed as an (R, R) -bimodule. Then, in particular, $M \otimes_R N$ becomes an R -module.
- (f) **Tensor product of morphisms:** Let $f : M \rightarrow M'$ be a morphism of right R -modules and $g : N \rightarrow N'$ be a morphism of left R -modules. Then, by the universal property of the tensor product, there exists a unique \mathbb{Z} -linear map $f \otimes g : M \otimes_R N \rightarrow M' \otimes_R N'$ such that $(f \otimes g)(m \otimes n) = f(m) \otimes g(n)$.

Proposition 7.7 (Right exactness of the tensor product)

- (a) Let N be a left R -module. Then $- \otimes_R N : \mathbf{Mod}_R \rightarrow \mathbf{Ab}$ is a right exact covariant functor.
- (b) Let M be a right R -module. Then $M \otimes_R - : {}_R \mathbf{Mod} \rightarrow \mathbf{Ab}$ is a right exact covariant functor.

Remark 7.8

The functors $- \otimes_R N$ and $M \otimes_R -$ are not left exact in general.

Definition 7.9 (Flat module)

A left R -module N is called **flat** if the functor $- \otimes_R N : \mathbf{Mod}_R \rightarrow \mathbf{Ab}$ is a left exact functor.

Proposition 7.10

Any projective R -module is flat.

Proof: To begin with, we note that a direct sum of modules is flat if and only if each module in the sum is flat. Next, consider the free R -module $P = \bigoplus_{x \in X} Rx$. If

$$0 \longrightarrow M_1 \xrightarrow{\varphi} M_2 \xrightarrow{\psi} M_3 \longrightarrow 0$$

is a short exact sequence of right R -modules, then we obtain

$$\begin{array}{ccccccc} 0 & \longrightarrow & M_1 \otimes_R \left(\bigoplus_{x \in X} R \right) & \xrightarrow{\varphi \otimes \text{Id}_P} & M_2 \otimes_R \left(\bigoplus_{x \in X} R \right) & \xrightarrow{\psi \otimes \text{Id}_P} & M_3 \otimes_R \left(\bigoplus_{x \in X} R \right) \longrightarrow 0 \\ & & \downarrow \cong & & \downarrow \cong & & \downarrow \cong \\ 0 & \longrightarrow & \bigoplus_{x \in X} M_1 & \xrightarrow{(\varphi)_{x \in X}} & \bigoplus_{x \in X} M_2 & \xrightarrow{(\psi)_{x \in X}} & \bigoplus_{x \in X} M_3 \longrightarrow 0. \end{array}$$

Since the original sequence is exact, so is the bottom sequence, and therefore so is the top sequence. Hence, $- \otimes_R P$ is exact when P is free.

Now, if N is a projective R -module, then $N \oplus N' = P'$ for some free R -module P' and for some R -module N' . It follows that N is flat, by the initial remark. ■

The aim of this chapter is to introduce the fundamental results of homological algebra. Homological algebra appeared in the 1800's and is nowadays a very useful tool in several branches of mathematics, such as algebraic topology, commutative algebra, algebraic geometry, and, of particular interest to us, group theory.

Throughout this chapter R denotes a ring, and unless otherwise specified, all rings are assumed to be *unital* and *associative*.

Reference:

- [Rot09] J. J. ROTMAN, *An introduction to homological algebra. Second ed.*, Universitext, Springer, New York, 2009.
- [Wei94] C. A. WEIBEL, *An introduction to homological algebra*, Cambridge Studies in Advanced Mathematics, vol. 38, Cambridge University Press, Cambridge, 1994.

8 Chain and Cochain Complexes

Definition 8.1 (*Chain complex*)

- (a) A **chain complex** (or simply a **complex**) of R -modules is a sequence

$$(C_\bullet, d_\bullet) = \left(\cdots \longrightarrow C_{n+1} \xrightarrow{d_{n+1}} C_n \xrightarrow{d_n} C_{n-1} \longrightarrow \cdots \right),$$

where for each $n \in \mathbb{Z}$, C_n is an R -modules and $d_n \in \text{Hom}_R(C_n, C_{n-1})$ satisfies $d_n \circ d_{n+1} = 0$. We often write simply C_\bullet instead of (C_\bullet, d_\bullet) .

- (b) The integer n is called the **degree** of the R -module C_n .
- (c) The R -linear maps d_n ($n \in \mathbb{Z}$) are called the **differential maps**.
- (d) A complex C_\bullet is called **non-negative** (resp. **positive**) if $C_n = 0$, for all $n \in \mathbb{Z}_{<0}$ (resp. for all $n \in \mathbb{Z}_{\leq 0}$).

Notice that sometimes we will omit the indices and write d for all differential maps, and thus the

condition $d_n \circ d_{n+1} = 0$ can be written as $d^2 = 0$. If there is an integer N such that $C_n = 0$ for all $n \leq N$, then we omit to write the zero modules and zero maps on the right-hand side of the complex:

$$\cdots \longrightarrow C_{N+2} \xrightarrow{d_{N+2}} C_{N+1} \xrightarrow{d_{N+1}} C_N$$

Similarly, if there is an integer N such that $C_n = 0$ for all $n \geq N$, then we omit to write the zero modules and zero maps on the left-hand side of the complex:

$$C_N \xrightarrow{d_N} C_{N-1} \xrightarrow{d_{N-1}} C_{N-2} \longrightarrow \cdots$$

Definition 8.2 (Morphism of complexes)

A **morphism of complexes** (or a **chain map**) between two chain complexes (C_\bullet, d_\bullet) and (D_\bullet, d'_\bullet) , written $\varphi_\bullet : C_\bullet \rightarrow D_\bullet$, is a family of R -linear maps $\varphi_n : C_n \rightarrow D_n$ ($n \in \mathbb{Z}$) such that $\varphi_n \circ d_{n+1} = d'_{n+1} \circ \varphi_{n+1}$ for each $n \in \mathbb{Z}$, that is such that the following diagram commutes:

$$\begin{array}{ccccccc} \cdots & \xrightarrow{d_{n+2}} & C_{n+1} & \xrightarrow{d_{n+1}} & C_n & \xrightarrow{d_n} & C_{n-1} & \xrightarrow{d_{n-1}} & \cdots \\ & & \varphi_{n+1} \downarrow & & \varphi_n \downarrow & & \varphi_{n-1} \downarrow & & \\ \cdots & \xrightarrow{d'_{n+2}} & D_{n+1} & \xrightarrow{d'_{n+1}} & D_n & \xrightarrow{d'_n} & D_{n-1} & \xrightarrow{d'_{n-1}} & \cdots \end{array}$$

Notation. Chain complexes together with morphisms of chain complexes (and composition given by degreewise composition of R -morphisms) form a category, which we will denote by $\mathbf{Ch}(R\mathbf{Mod})$.

Definition 8.3 (Subcomplex / quotient complex)

- (a) A **subcomplex** C'_\bullet of a chain complex (C_\bullet, d_\bullet) is a family of R -modules $C'_n \leq C_n$ ($n \in \mathbb{Z}$), such that $d_n(C'_n) \subset C'_{n-1}$ for every $n \in \mathbb{Z}$.
In this case, (C'_\bullet, d_\bullet) becomes a chain complex and the inclusion $C'_\bullet \hookrightarrow C_\bullet$ given by the canonical inclusion of C'_n into C_n for each $n \in \mathbb{Z}$ is a chain map.
- (b) If C'_\bullet is a subcomplex of C_\bullet , then the **quotient complex** C_\bullet/C'_\bullet is the family of R -modules C_n/C'_n ($n \in \mathbb{Z}$) together with the differential maps $\bar{d}_n : C_n/C'_n \rightarrow C_{n-1}/C'_{n-1}$ uniquely determined by the universal property of the quotient.
In this case, the quotient map $\pi_\bullet : C_\bullet \rightarrow C_\bullet/C'_\bullet$ defined for each $n \in \mathbb{Z}$ by the canonical projection $\pi_n : C_n \rightarrow C_n/C'_n$ is a chain map.

Definition 8.4 (Kernel / image / cokernel)

Let $\varphi_\bullet : C_\bullet \rightarrow D_\bullet$ be a morphism of chain complexes between (C_\bullet, d_\bullet) and (D_\bullet, d'_\bullet) . Then,

- (a) the **kernel** of φ_\bullet is the subcomplex of C_\bullet defined by $\ker \varphi_\bullet := (\{\ker \varphi_n\}_{n \in \mathbb{Z}}, d_\bullet)$;
- (b) the **image** of φ_\bullet is the subcomplex of D_\bullet defined by $\text{Im } \varphi_\bullet := (\{\text{Im } \varphi_n\}_{n \in \mathbb{Z}}, d'_\bullet)$; and
- (c) the **cokernel** of φ_\bullet is the quotient complex $\text{coker } \varphi_\bullet := D_\bullet/\text{Im } \varphi_\bullet$.

With these notions of kernel and cokernel, one can show that $\mathbf{Ch}(\mathcal{R}\mathbf{Mod})$ is in fact an abelian category.

Definition 8.5 (Cycles, boundaries, homology)

Let (C_\bullet, d_\bullet) be a chain complex of R -modules.

- (a) An n -cycle is an element of $\ker d_n =: Z_n(C_\bullet) := Z_n$.
- (b) An n -boundary is an element of $\text{Im } d_{n+1} =: B_n(C_\bullet) := B_n$.
[Clearly, since $d_n \circ d_{n+1} = 0$, we have $0 \subseteq B_n \subseteq Z_n \subseteq C_n \forall n \in \mathbb{Z}$.]
- (c) The n -th homology module (or simply group) of C_\bullet is $H_n(C_\bullet) := Z_n/B_n$.

In fact, for each $n \in \mathbb{Z}$, $H_n(-) : \mathbf{Ch}(\mathcal{R}\mathbf{Mod}) \rightarrow \mathcal{R}\mathbf{Mod}$ is a covariant additive functor (see Exercise 1, Exercise Sheet 6), which we define on morphisms as follows:

Lemma 8.6

Let $\varphi_\bullet : C_\bullet \rightarrow D_\bullet$ be a morphism of chain complexes between (C_\bullet, d_\bullet) and (D_\bullet, d'_\bullet) . Then φ_\bullet induces an R -linear map

$$H_n(\varphi_\bullet) : \begin{array}{ccc} H_n(C_\bullet) & \longrightarrow & H_n(D_\bullet) \\ z_n + B_n(C_\bullet) & \mapsto & \varphi_n(z_n) + B_n(D_\bullet) \end{array}$$

for each $n \in \mathbb{Z}$. To simplify, this map is often denoted by φ_* instead of $H_n(\varphi_\bullet)$.

Proof: Fix $n \in \mathbb{Z}$, and let $\pi_n : Z_n(C_\bullet) \rightarrow Z_n(C_\bullet)/B_n(C_\bullet)$, resp. $\pi'_n : Z_n(D_\bullet) \rightarrow Z_n(D_\bullet)/B_n(D_\bullet)$, be the canonical projections.

First, notice that $\varphi_n(Z_n(C_\bullet)) \subseteq Z_n(D_\bullet)$ because if $z \in Z_n$, then $d'_n \circ \varphi_n(z) = \varphi_{n-1} \circ d_n(z) = 0$. Hence, we have $\varphi_n(z) \in Z_n(D_\bullet)$.

Similarly, we have $\varphi_n(B_n(C_\bullet)) \subseteq B_n(D_\bullet)$. Indeed, if $b \in B_n(C_\bullet)$, then $b = d_{n+1}(a)$ for some $a \in C_{n+1}$, and because φ_\bullet is a chain map we have $\varphi_n(b) = \varphi_n \circ d'_{n+1}(a) = d_{n+1} \circ \varphi_{n+1}(a) \in B_n(D_\bullet)$.

Therefore, by the universal property of the quotient, there exists a unique R -linear map $\overline{\pi'_n \circ \varphi_n}$ such that the following diagram commutes:

$$\begin{array}{ccccc} Z_n(C_\bullet) & \xrightarrow{\varphi_n} & Z_n(D_\bullet) & \xrightarrow{\pi'_n} & Z_n(D_\bullet)/B_n(D_\bullet) \\ \pi_n \downarrow & & \nearrow \overline{\pi'_n \circ \varphi_n} & & \nearrow \\ Z_n(C_\bullet)/B_n(C_\bullet) & & & & \end{array}$$

Set $H_n(\varphi_\bullet) := \overline{\pi'_n \circ \varphi_n}$. The claim follows. ■

It should be thought that the homology module $H_n(C_\bullet)$ measures the "non-exactness" of the sequence

$$C_{n+1} \xrightarrow{d_{n+1}} C_n \xrightarrow{d_n} C_{n-1} .$$

Moreover, the functors $H_n(-)$ ($n \in \mathbb{Z}$) are neither left exact, nor right exact in general. As a matter of fact, using the Snake Lemma, we can use s.e.s. of complexes to produce so-called "long exact sequences" of R -modules.

Theorem 8.7 (Long exact sequence in homology)

Let $0_\bullet \longrightarrow C_\bullet \xrightarrow{\varphi_\bullet} D_\bullet \xrightarrow{\psi_\bullet} E_\bullet \longrightarrow 0_\bullet$ be a s.e.s. of chain complexes. Then there is a long exact sequence

$$\cdots \xrightarrow{\delta_{n+1}} H_n(C_\bullet) \xrightarrow{\varphi_*} H_n(D_\bullet) \xrightarrow{\psi_*} H_n(E_\bullet) \xrightarrow{\delta_n} H_{n-1}(C_\bullet) \xrightarrow{\varphi_*} H_{n-1}(D_\bullet) \xrightarrow{\psi_*} \cdots,$$

where for each $n \in \mathbb{Z}$, $\delta_n : H_n(E_\bullet) \longrightarrow H_{n-1}(C_\bullet)$ is an R -linear map, called **connecting homomorphism**.

Note: Here 0_\bullet simply denotes the **zero complex**, that is the complex

$$\cdots \longrightarrow 0 \xrightarrow{0} 0 \xrightarrow{0} 0 \longrightarrow \cdots$$

consisting of zero modules and zero morphisms. We often write simply 0 instead of 0_\bullet .

Proof: To simplify, we denote all differential maps of the three complexes C_\bullet , D_\bullet , E_\bullet with the same letter d , and we fix $n \in \mathbb{Z}$. First, we apply the “non-snake” part of the Snake Lemma to the commutative diagram

$$\begin{array}{ccccccccc} 0 & \longrightarrow & C_n & \xrightarrow{\varphi_n} & D_n & \xrightarrow{\psi_n} & E_n & \longrightarrow & 0 \\ & & \downarrow d_n & & \downarrow d_n & & \downarrow d_n & & \\ 0 & \longrightarrow & C_{n-1} & \xrightarrow{\varphi_{n-1}} & D_{n-1} & \xrightarrow{\psi_{n-1}} & E_{n-1} & \longrightarrow & 0, \end{array}$$

and we obtain two exact sequences

$$0 \longrightarrow Z_n(C_\bullet) \xrightarrow{\varphi_n} Z_n(D_\bullet) \xrightarrow{\psi_n} Z_n(E_\bullet),$$

and

$$C_{n-1}/\text{Im } d_n \xrightarrow{\overline{\varphi_{n-1}}} D_{n-1}/\text{Im } d_n \xrightarrow{\overline{\psi_{n-1}}} E_{n-1}/\text{Im } d_n \longrightarrow 0.$$

Shifting indices in both sequences we obtain similar sequences in degrees $n-1$, and n respectively. Therefore, we have a commutative diagram with exact rows of the form:

$$\begin{array}{ccccccccc} C_n/\text{Im } d_{n+1} & \xrightarrow{\overline{\varphi_n}} & D_n/\text{Im } d_{n+1} & \xrightarrow{\overline{\psi_n}} & E_n/\text{Im } d_{n+1} & \longrightarrow & 0 \\ & & \downarrow \overline{d_n} & & \downarrow \overline{d_n} & & \downarrow \overline{d_n} \\ 0 & \longrightarrow & Z_{n-1}(C_\bullet) & \xrightarrow{\varphi_{n-1}} & Z_{n-1}(D_\bullet) & \xrightarrow{\psi_{n-1}} & Z_{n-1}(E_\bullet), \end{array}$$

where $\overline{d_n} : C_n/\text{Im } d_{n+1} \longrightarrow Z_{n-1}(C_\bullet)$ is the unique R -linear map induced by the universal property of the quotient by $d_n : C_n \longrightarrow C_{n-1}$ (as $\text{Im } d_{n+1} \subseteq \ker d_n$ by definition of a chain complex), and similarly for D_\bullet and E_\bullet . Therefore, the Snake Lemma yields the existence of the connecting homomorphisms

$$\delta_n : \underbrace{\ker \overline{d_n}(E_\bullet)}_{=H_n(E_\bullet)} \longrightarrow \underbrace{\text{coker } \overline{d_n}(C_\bullet)}_{=H_{n-1}(C_\bullet)}$$

for each $n \in \mathbb{Z}$ as well as the required long exact sequence:

$$\cdots \xrightarrow{\delta_{n+1}} \underbrace{H_n(C_\bullet)}_{=\ker \overline{d_n}} \xrightarrow{\varphi_*} \underbrace{H_n(D_\bullet)}_{=\ker \overline{d_n}} \xrightarrow{\psi_*} \underbrace{H_n(E_\bullet)}_{=\ker \overline{d_n}} \xrightarrow{\delta_n} \underbrace{H_{n-1}(C_\bullet)}_{=\text{coker } \overline{d_n}} \xrightarrow{\varphi_*} \underbrace{H_{n-1}(D_\bullet)}_{=\text{coker } \overline{d_n}} \xrightarrow{\psi_*} \cdots$$

■

We now describe some important properties of chain maps and how they relate with the induced morphisms in homology.

Definition 8.8 (Quasi-isomorphism)

A chain map $\varphi_\bullet : C_\bullet \rightarrow D_\bullet$ is called a **quasi-isomorphism** if $H_n(\varphi_\bullet)$ is an isomorphism for all $n \in \mathbb{Z}$.

Warning: A quasi-isomorphism does not imply that the complexes C_\bullet and D_\bullet are isomorphic as chain complexes. See Exercise 2, Sheet 5 for a counter-example.

In general complexes are not exact sequences, but if they are, then their homology vanishes, so that there is a quasi-isomorphism from the zero complex.

Exercise [Exercise 3, Exercise Sheet 5]

Let C_\bullet be a chain complex of R -modules. Prove that TFAE:

- (a) C_\bullet is **exact** (i.e. exact at C_n for each $n \in \mathbb{Z}$);
- (b) C_\bullet is **acyclic**, that is, $H_n(C_\bullet) = 0$ for all $n \in \mathbb{Z}$;
- (c) The map $0_\bullet \rightarrow C_\bullet$ is a quasi-isomorphism.

Definition 8.9 (Homotopic chain maps / homotopy equivalence)

Two chain maps $\varphi_\bullet, \psi_\bullet : C_\bullet \rightarrow D_\bullet$ between chain complexes (C_\bullet, d_\bullet) and (D_\bullet, d'_\bullet) are called **(chain) homotopic** if there exists a family of R -linear maps $\{s_n : C_n \rightarrow D_{n+1}\}_{n \in \mathbb{Z}}$ such that

$$\varphi_n - \psi_n = d'_{n+1} \circ s_n + s_{n-1} \circ d_n$$

for each $n \in \mathbb{Z}$.

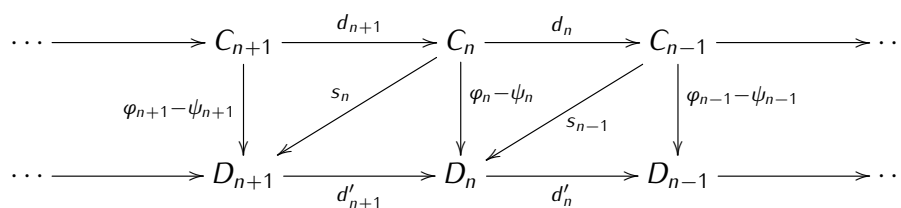

In this case, we write $\varphi_\bullet \sim \psi_\bullet$.

Moreover, a chain map $\varphi_\bullet : C_\bullet \rightarrow D_\bullet$ is called a **homotopy equivalence** if there exists a chain map $\sigma : D_\bullet \rightarrow C_\bullet$ such that $\sigma_\bullet \circ \varphi_\bullet \sim \text{id}_{C_\bullet}$ and $\varphi_\bullet \circ \sigma_\bullet \sim \text{id}_{D_\bullet}$.

Note: One easily checks that \sim is an equivalence relation on the class of chain maps.

Proposition 8.10

If $\varphi_\bullet, \psi_\bullet : C_\bullet \rightarrow D_\bullet$ are homotopic morphisms of chain complexes, then they induce the same morphisms in homology, that is

$$H_n(\varphi_\bullet) = H_n(\psi_\bullet) : H_n(C_\bullet) \rightarrow H_n(D_\bullet) \quad \forall n \in \mathbb{Z}.$$

Proof: Fix $n \in \mathbb{Z}$ and let $z \in Z_n(C_\bullet)$. Then, with the notation of Definition 8.9, we have

$$(\varphi_n - \psi_n)(z) = (d'_{n+1}s_n + s_{n-1}d_n)(z) = \underbrace{d'_{n+1}s_n(z)}_{\in B_n(D_\bullet)} + \underbrace{s_{n-1}d_n(z)}_{=0} \in B_n(D_\bullet).$$

Hence, for every $z + B_n(C_\bullet) \in H_n(C_\bullet)$, we have

$$(H_n(\varphi_\bullet) - H_n(\psi_\bullet))(z + B_n(C_\bullet)) = H_n(\varphi_\bullet - \psi_\bullet)(z + B_n(C_\bullet)) = 0 + B_n(D_\bullet).$$

In other words $H_n(\varphi_\bullet) - H_n(\psi_\bullet) \equiv 0$, so that $H_n(\varphi_\bullet) = H_n(\psi_\bullet)$. ■

Remark 8.11

(Out of the scope of the lecture!)

Homotopy of complexes leads to considering the so-called **homotopy category** of R -modules, denoted $\mathbf{Ho}(R\mathbf{Mod})$, which is very useful in algebraic topology or representation theory of finite groups for example. It is defined as follows:

- The objects are the chain complexes, i.e. $\text{Ob } \mathbf{Ho}(R\mathbf{Mod}) = \text{Ob } \mathbf{Ch}(R\mathbf{Mod})$.
- The morphisms are given by $\text{Hom}_{\mathbf{Ho}(R\mathbf{Mod})} := \text{Hom}_{\mathbf{Ch}(R\mathbf{Mod})} / \sim$.

It is an additive category, but it is not abelian in general though. The isomorphisms in the homotopy category are exactly the classes of the homotopy equivalences.

Dualizing the objects and concepts we have defined above yields the so-called "cochain complexes" and the notion of "cohomology".

Definition 8.12 (Cochain complex / cohomology)

(a) A **cochain complex** of R -modules is a sequence

$$(C^\bullet, d^\bullet) = \left(\dots \longrightarrow C^{n-1} \xrightarrow{d_{n-1}} C^n \xrightarrow{d^n} C^{n+1} \longrightarrow \dots \right),$$

where for each $n \in \mathbb{Z}$, C^n is an R -module and $d^n \in \text{Hom}_R(C^n, C^{n+1})$ satisfies $d^{n+1} \circ d^n = 0$. We often write simply C^\bullet instead of (C^\bullet, d^\bullet) .

- (b) The elements of $Z^n := Z^n(C^\bullet) := \ker d^n$ are the **n -cocycles**.
- (c) The elements of $B^n := B^n(C^\bullet) := \text{Im } d^{n-1}$ are the **n -coboundaries**.
- (d) The **n -th cohomology module** (or simply **group**) of C^\bullet is $H^n(C^\bullet) := Z^n/B^n$.

Similarly to the case of chain complexes, we can define:

- **Morphisms of cochain complexes** (or simply **cochain maps**) between two cochain complexes (C^\bullet, d^\bullet) and $(D^\bullet, \tilde{d}^\bullet)$, written $\varphi^\bullet : C^\bullet \longrightarrow D^\bullet$, as a family of R -linear maps $\varphi^n : C^n \longrightarrow D^n$ ($n \in \mathbb{Z}$) such that $\varphi^n \circ d^{n-1} = \tilde{d}^{n-1} \circ \varphi^{n-1}$ for each $n \in \mathbb{Z}$, that is such that the following diagram

commutes:

$$\begin{array}{ccccccc}
 \dots & \xrightarrow{d^{n-2}} & C^{n-1} & \xrightarrow{d^{n-1}} & C^n & \xrightarrow{d^n} & C^{n+1} \xrightarrow{d^{n+1}} \dots \\
 & & \downarrow \varphi^{n-1} & & \downarrow \varphi^n & & \downarrow \varphi^{n+1} \\
 \dots & \xrightarrow{\tilde{d}^{n-2}} & D^{n-1} & \xrightarrow{\tilde{d}^{n-1}} & D^n & \xrightarrow{\tilde{d}^n} & D^{n+1} \xrightarrow{\tilde{d}^{n+1}} \dots
 \end{array}$$

- subcomplexes, quotient complexes;
- kernels, images, cokernels of morphisms of cochain complexes.
- Cochain complexes together with morphisms of cochain complexes (and composition given by degreewise composition of R -morphisms) form an abelian category, which we will denote by $\text{CoCh}(R\text{Mod})$.

Exercise: formulate these definitions in a formal way.

Theorem 8.13 (Long exact sequence in cohomology)

Let $0^\bullet \longrightarrow C^\bullet \xrightarrow{\varphi^\bullet} D^\bullet \xrightarrow{\psi^\bullet} E^\bullet \longrightarrow 0^\bullet$ be a s.e.s. of cochain complexes. Then, for each $n \in \mathbb{Z}$, there exists a connecting homomorphism $\delta^n : H^n(E^\bullet) \longrightarrow H^{n+1}(C^\bullet)$ such that the following sequence is exact:

$$\dots \xrightarrow{\delta^{n+1}} H^n(C^\bullet) \xrightarrow{\varphi^*} H^n(D^\bullet) \xrightarrow{\psi^*} H^n(E^\bullet) \xrightarrow{\delta^n} H^{n+1}(C^\bullet) \xrightarrow{\varphi^*} H^{n+1}(D^\bullet) \xrightarrow{\psi^*} \dots$$

Proof: Similar to the proof of the long exact sequence in homology (Theorem 8.7). Apply the Snake Lemma. ■

9 Projective Resolutions

Definition 9.1 (Projective resolution)

Let M be an R -module. A **projective resolution** of M is a non-negative complex of projective R -modules

$$(P_\bullet, d_\bullet) = (\dots \xrightarrow{d_3} P_2 \xrightarrow{d_2} P_1 \xrightarrow{d_1} P_0)$$

which is exact at P_n for every $n \geq 1$ and such that $H_0(P_\bullet) = P_0 / \text{Im } d_1 \cong M$.

Moreover, if P_n is a free R -module for every $n \geq 0$, then P_\bullet is called a **free resolution** of M .

Notation: Letting $\varepsilon : P_0 \rightarrow M$ denote the quotient homomorphism, we have a so-called **augmented complex**

$$\dots \xrightarrow{d_3} P_2 \xrightarrow{d_2} P_1 \xrightarrow{d_1} P_0 \xrightarrow{\varepsilon} M \longrightarrow 0,$$

associated to the projective resolution, and this augmented complex is exact. Hence we will also denote projective resolutions of M by $P_\bullet \xrightarrow{\varepsilon} M$.

Example 8

The \mathbb{Z} -module $M = \mathbb{Z}/n\mathbb{Z}$ admits the following projective resolution: $0 \longrightarrow \mathbb{Z} \xrightarrow{\cdot n} \mathbb{Z} \longrightarrow 0$.

We now prove that projective resolutions do exist, and consider the question of how "unique" they are.

Proposition 9.2

Any R -module has a projective resolution. (It can even chosen to be free.)

Proof: We use the fact that every R -module is a quotient of a free R -module (Proposition 6.4). Thus there exists a free module P_0 together with a surjective R -linear map $\varepsilon : P_0 \twoheadrightarrow M$ such that $M \cong P_0/\ker \varepsilon$. Next, let P_1 be a free R -module together with a surjective R -linear map $d_1 : P_1 \twoheadrightarrow \ker \varepsilon \subseteq P_0$ such that $P_1/\ker d_1 \cong \ker \varepsilon$:

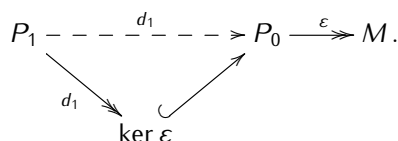

Inductively, assuming that the R -homomorphism $d_{n-1} : P_{n-1} \twoheadrightarrow P_{n-2}$ has already been defined, then there exists a free R -module P_n and a surjective R -linear map $d_n : P_n \twoheadrightarrow \ker d_{n-1} \subseteq P_{n-1}$ with $P_n/\ker d_n \cong \ker d_{n-1}$. The claim follows. ■

Theorem 9.3 (Lifting Theorem)

Let (P_\bullet, d_\bullet) and (Q_\bullet, d'_\bullet) be two non-negative chain complexes such that

1. P_n is a projective R -module for every $n \geq 0$;
2. Q_\bullet is exact at Q_n for every $n \geq 1$ (that is $H_n(Q_\bullet) = 0$, for all $n \geq 1$).

Let $\varepsilon : P_0 \twoheadrightarrow H_0(P_\bullet)$ and $\varepsilon' : Q_0 \twoheadrightarrow H_0(Q_\bullet)$ be the quotient homomorphisms.

If $f : H_0(P_\bullet) \rightarrow H_0(Q_\bullet)$ is an R -linear map, then there exists a chain map $\varphi_\bullet : P_\bullet \rightarrow Q_\bullet$ inducing the given map f in degree-zero homology, that is such that $H_0(\varphi_\bullet) = f$ and $f \circ \varepsilon = \varepsilon' \circ \varphi_0$. Moreover, such a chain map φ_\bullet is unique up to homotopy.

In the situation of the Theorem, it is said that φ_\bullet **lifts** f .

Proof: Existence. Because P_0 is projective and ε' is surjective, by definition (Def. 6.7), there exists an R -linear map $\varphi_0 : P_0 \rightarrow Q_0$ such that the following diagram commutes

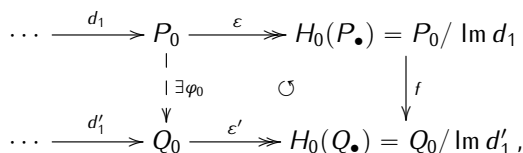

that is $f \circ \varepsilon = \varepsilon' \circ \varphi_0$. But then, $\varepsilon' \circ \varphi_0 \circ d_1 = f \circ \underbrace{\varepsilon \circ d_1}_{=0} = 0$, so that $\text{Im}(\varphi_0 \circ d_1) \subseteq \ker \varepsilon' = \text{Im } d'_1$. Again

by Definition 6.7, since P_1 is projective and d'_1 is surjective onto its image, there exists an R -linear map $\varphi_1 : P_1 \rightarrow Q_1$ such that $\varphi_0 \circ d_1 = d'_1 \circ \varphi_1$:

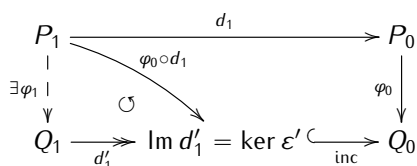

The morphisms $\varphi_n : P_n \rightarrow Q_n$ are constructed similarly by induction on n . Hence the existence of a chain map $\varphi_\bullet : P_\bullet \rightarrow Q_\bullet$ as required.

Uniqueness. For the uniqueness statement, suppose $\psi_\bullet : P_\bullet \rightarrow Q_\bullet$ also lifts the given morphism f . We have to prove that $\varphi_\bullet \sim \psi_\bullet$ (or equivalently that $\varphi_\bullet - \psi_\bullet$ is homotopic to the zero chain map).

For each $n \geq 0$ set $\sigma_n := \varphi_n - \psi_n$, so that $\sigma_\bullet : P_\bullet \rightarrow Q_\bullet$ is becomes a chain map. In particular $\sigma_0 = \varphi_0 - \psi_0 = H_0(\varphi_\bullet) - H_0(\psi_\bullet) = f - f = 0$. Then we let $s_{-2} : 0 \rightarrow H_0(Q_\bullet)$ and $s_{-1} : H_0(P_\bullet) \rightarrow Q_0$ be the zero maps. Therefore, in degree zero, we have the following maps:

$$\begin{array}{ccccc} P_0 & \xrightarrow{\varepsilon} & H_0(P_\bullet) & \xrightarrow{0} & 0 \\ & \searrow s_{-1} & \downarrow 0 & \swarrow s_{-2} & \\ Q_0 & \xrightarrow{\varepsilon'} & H_0(Q_\bullet) & \xrightarrow{0} & 0, \end{array}$$

where clearly $0 = s_{-2} \circ 0 + \varepsilon' \circ s_{-1}$. This provides us with the starting point for constructing a homotopy $s_n : P_n \rightarrow Q_{n+1}$ by induction on n . So let $n \geq 0$ and suppose $s_i : P_i \rightarrow Q_{i+1}$ is already constructed for each $-2 \leq i \leq n-1$ and satisfies $d'_{i+1} \circ s_i + s_{i-1} \circ d_i = \sigma_i$ for each $i \geq -1$, and where we identify

$$P_{-1} = H_0(P_\bullet), \quad Q_{-1} = H_0(Q_\bullet), \quad P_{-2} = 0 = Q_{-2}, \quad d_0 = \varepsilon, \quad d'_0 = \varepsilon', \quad d_{-1} = 0 = d'_{-1}.$$

Now, we check that the image of $\sigma_n - s_{n-1} \circ d_n$ is contained in $\ker d'_n = \text{Im } d'_{n+1}$:

$$\begin{aligned} d'_n \circ (\sigma_n - s_{n-1} \circ d_n) &= d'_n \circ \sigma_n - d'_n \circ s_{n-1} \circ d_n \\ &= d'_n \circ \sigma_n - (\sigma_{n-1} - s_{n-2} \circ d_{n-1}) \circ d_n \\ &= d'_n \circ \sigma_n - \sigma_{n-1} \circ d_n \\ &= \sigma_{n-1} \circ d_n - \sigma_{n-1} \circ d_n = 0, \end{aligned}$$

where the last-but-one equality holds because both σ_\bullet is a chain map. Therefore, again by Definition 6.7, since P_n is projective and d'_{n+1} is surjective onto its image, there exists an R -linear map $s_n : P_n \rightarrow Q_{n+1}$ such that $d'_{n+1} \circ s_n = \sigma_n - s_{n-1} \circ d_n$:

$$\begin{array}{ccccccc} & & P_n & \xrightarrow{d_n} & P_{n-1} & \xrightarrow{d_{n-1}} & P_{n-2} & \longrightarrow & \dots \\ & \swarrow \exists s_n & \downarrow \sigma_n - s_{n-1} \circ d_n & \swarrow s_{n-1} & \downarrow \sigma_{n-1} & \swarrow s_{n-2} & \downarrow \sigma_{n-2} & \swarrow & \\ Q_{n+1} & \xrightarrow{d'_{n+1}} & Q_n & \xrightarrow{d'_n} & Q_{n-1} & \xrightarrow{d'_{n-1}} & Q_{n-2} & \longrightarrow & \dots \end{array}$$

Hence we have $\varphi_n - \psi_n = \sigma_n = d'_{n+1} \circ s_n + s_{n-1} \circ d_n$, as required. ■

As a corollary, we obtain the required statement on the uniqueness of projective resolutions:

Theorem 9.4 (Comparison Theorem)

Let $P_\bullet \xrightarrow{\varepsilon} M$ and $Q_\bullet \xrightarrow{\varepsilon'} M$ be two projective resolutions of an R -module M . Then P_\bullet and Q_\bullet are homotopy equivalent. More precisely, there exist chain maps $\varphi_\bullet : P_\bullet \rightarrow Q_\bullet$ and $\psi_\bullet : Q_\bullet \rightarrow P_\bullet$ lifting the identity on M and such that $\psi_\bullet \circ \varphi_\bullet \sim \text{Id}_{P_\bullet}$ and $\varphi_\bullet \circ \psi_\bullet \sim \text{Id}_{Q_\bullet}$.

Proof: Consider the identity morphism $\text{Id}_M : M \rightarrow M$.

By the Lifting Theorem, there exists a chain map $\varphi_\bullet : P_\bullet \rightarrow Q_\bullet$, unique up to homotopy, such that $H_0(\varphi_\bullet) = \text{Id}_M$ and $\text{Id}_M \circ \varepsilon = \varepsilon' \circ \varphi_0$. Likewise, there exists a chain map $\psi_\bullet : Q_\bullet \rightarrow P_\bullet$, unique up to homotopy, such that $H_0(\psi_\bullet) = \text{Id}_M$ and $\text{Id}_M \circ \varepsilon' = \varepsilon \circ \psi_0$.

$$\begin{array}{ccccccc}
 \dots & \longrightarrow & P_n & \xrightarrow{d_n} & \dots & \longrightarrow & P_1 & \xrightarrow{d_1} & P_0 & \xrightarrow{\epsilon} & M & \longrightarrow & 0 \\
 & & \uparrow & & \uparrow & & \uparrow & & \uparrow & & \uparrow & & \\
 \dots & & \exists \psi_n & | & \exists \varphi_n & & \dots & & \exists \psi_1 & | & \exists \varphi_1 & \circlearrowleft & \exists \psi_0 & | & \exists \varphi_0 & \circlearrowleft & \text{Id}_M & \updownarrow & \text{Id}_M \\
 & & | & & | & & | & & | & & | & & | & & | & & & & \\
 \dots & \longrightarrow & Q_n & \xrightarrow{d'_n} & \dots & \longrightarrow & Q_1 & \xrightarrow{d'_1} & Q_0 & \xrightarrow{\epsilon'} & M & \longrightarrow & 0
 \end{array}$$

Now, $\psi_\bullet \circ \varphi_\bullet$ and Id_{P_\bullet} are both chain maps that lift the identity map $\text{Id}_M : H_0(P_\bullet) \rightarrow H_0(P_\bullet)$. Therefore, by the uniqueness statement in the Lifting Theorem, we have $\psi_\bullet \circ \varphi_\bullet \sim \text{Id}_{P_\bullet}$. Likewise, $\varphi_\bullet \circ \psi_\bullet$ and Id_{Q_\bullet} are both chain maps that lift the identity map $\text{Id}_M : H_0(Q_\bullet) \rightarrow H_0(Q_\bullet)$, therefore they are homotopic, that is $\varphi_\bullet \circ \psi_\bullet \sim \text{Id}_{Q_\bullet}$. ■

Another way to construct projective resolutions is given by the following Lemma, often called the *Horseshoe Lemma*, because it requires to fill in a horseshoe-shaped diagram:

Lemma 9.5 (Horseshoe Lemma)

Let $0 \rightarrow M' \rightarrow M \rightarrow M'' \rightarrow 0$ be a short exact sequence of R -modules. Let $P'_\bullet \xrightarrow{\epsilon'} M'$ be a resolution of M' and $P''_\bullet \xrightarrow{\epsilon''} M''$ be a **projective** resolution of M'' .

$$\begin{array}{ccccccc}
 & & \vdots & & \vdots & & \\
 & & \downarrow & & \downarrow & & \\
 & & P'_1 & & P''_1 & & \\
 & & \downarrow & & \downarrow & & \\
 & & P'_0 & & P''_0 & & \\
 & & \downarrow & & \downarrow & & \\
 0 & \longrightarrow & M' & \longrightarrow & M & \longrightarrow & M'' & \longrightarrow & 0 \\
 & & \downarrow & & & & \downarrow & & \\
 & & 0 & & & & 0 & &
 \end{array}$$

Then, there exists a resolution $P_\bullet \xrightarrow{\epsilon} M$ of M such that $P_n \cong P'_n \oplus P''_n$ for each $n \in \mathbb{Z}_{\geq 0}$ and the s.e.s. $0 \rightarrow M' \rightarrow M \rightarrow M'' \rightarrow 0$ lifts to a s.e.s. of chain complexes $0_\bullet \rightarrow P'_\bullet \xrightarrow{i_\bullet} P_\bullet \xrightarrow{\pi_\bullet} P''_\bullet \rightarrow 0_\bullet$ where i_\bullet and π_\bullet are the canonical injection and projection. Moreover, if $P'_\bullet \xrightarrow{\epsilon'} M'$ is a projective resolution, then so is $P_\bullet \xrightarrow{\epsilon} M$.

Proof: Exercise 3, Exercise Sheet 6.

[Hint: Proceed by induction on n , and use the Snake Lemma.] ■

Finally, we note that dual to the notion of a projective resolution is the notion of an injective resolution:

Definition 9.6 (Injective resolution)

Let M be an R -module. An **injective resolution** of M is a non-negative cochain complex of injective

R -modules

$$(I^\bullet, d^\bullet) = (I^0 \xrightarrow{d^0} I^1 \xrightarrow{d^1} I^2 \xrightarrow{d^2} \dots)$$

which is exact at I^n for every $n \geq 1$ and such that $H^0(I^\bullet) = \ker d^0/0 \cong M$.

Notation: Letting $\iota : M \hookrightarrow I^0$ denote the natural injection, we have a so-called **augmented complex**

$$M \xrightarrow{\iota} I^0 \xrightarrow{d^0} I^1 \xrightarrow{d^1} I^2 \longrightarrow \dots$$

associated to the injective resolution (I^\bullet, d^\bullet) , and this augmented complex is exact. Hence we will also denote injective resolutions of M by $M \hookrightarrow I^\bullet$.

Similarly to projective resolutions, one can prove that an injective resolution always exists. There is also a Lifting Theorem and a Comparison Theorem for injective resolutions, so that they are unique up to homotopy (of cochain complexes).

10 Ext and Tor

We now introduce the Ext and Tor groups, which are cohomology and homology groups obtained from applying Hom and tensor product functors to projective/injective resolutions. We will see later that Ext groups can be used in group cohomology to classify abelian group extensions.

Definition 10.1 (Ext-groups)

Let M and N be two left R -modules and let $P_\bullet \xrightarrow{\epsilon} M$ be a projective resolution of M . For $n \in \mathbb{Z}_{\geq 0}$, the **n -th Ext-group** of M and N is

$$\text{Ext}_R^n(M, N) := H^n(\text{Hom}_R(P_\bullet, N)),$$

that is, the n -th cohomology group of the cochain complex $\text{Hom}_R(P_\bullet, N)$.

Recipe:

1. Choose a projective resolution P_\bullet of M .
2. Apply the left exact contravariant functor $\text{Hom}_R(-, N)$ to the *projective resolution*

$$P_\bullet = (\dots \xrightarrow{d_3} P_2 \xrightarrow{d_2} P_1 \xrightarrow{d_1} P_0)$$

to obtain a *cochain complex*

$$\text{Hom}_R(P_0, N) \xrightarrow{d_1^*} \text{Hom}_R(P_1, N) \xrightarrow{d_2^*} \text{Hom}_R(P_2, N) \xrightarrow{d_3^*} \dots$$

of *abelian groups* (which is not exact in general).

3. Compute the cohomology of this new complex.

First of all, we have to check that the definition of the abelian groups $\text{Ext}_R^n(M, N)$ is independent from the choice of the projective resolution of M .

Proposition 10.2

If $P_\bullet \xrightarrow{\varepsilon} M$ and $Q_\bullet \xrightarrow{\varepsilon'} M$ are two projective resolutions of M , then the groups $H^n(\text{Hom}_R(P_\bullet, N))$ and $H^n(\text{Hom}_R(Q_\bullet, N))$ are (canonically) isomorphic, via the homomorphisms induced by the chain maps between P_\bullet and Q_\bullet given by the Comparison Theorem applied to the identity morphism Id_M .

Proof: By the Comparison Theorem, there exist chain maps $\varphi_\bullet : P_\bullet \rightarrow Q_\bullet$ and $\psi_\bullet : Q_\bullet \rightarrow P_\bullet$ lifting the identity on M and such that $\psi_\bullet \circ \varphi_\bullet \sim \text{Id}_{P_\bullet}$ and $\varphi_\bullet \circ \psi_\bullet \sim \text{Id}_{Q_\bullet}$.

Now, applying the functor $\text{Hom}_R(-, N)$ yields morphisms of cochain complexes

$$\varphi^* : \text{Hom}_R(Q_\bullet, N) \rightarrow \text{Hom}_R(P_\bullet, N) \quad \text{and} \quad \psi^* : \text{Hom}_R(P_\bullet, N) \rightarrow \text{Hom}_R(Q_\bullet, N).$$

Since $\varphi_\bullet \circ \psi_\bullet \sim \text{Id}_{Q_\bullet}$ and $\psi_\bullet \circ \varphi_\bullet \sim \text{Id}_{P_\bullet}$, it follows that $\varphi^* \circ \psi^* \sim \text{Id}_{\text{Hom}_R(P_\bullet, N)}$ and $\psi^* \circ \varphi^* \sim \text{Id}_{\text{Hom}_R(Q_\bullet, N)}$.

But then, passing to cohomology, φ^* induces a group homomorphism

$$\overline{\varphi^*} : H^n(\text{Hom}_R(Q_\bullet, N)) \rightarrow H^n(\text{Hom}_R(P_\bullet, N))$$

(see Exercise 1, Exercise Sheet 5). Since φ_\bullet is unique up to homotopy, so is φ^* , and hence $\overline{\varphi^*}$ is unique because homotopic chain maps induce the same morphisms in cohomology. Likewise, there is a unique homomorphism $\overline{\psi^*} : H^n(\text{Hom}_R(P_\bullet, N)) \rightarrow H^n(\text{Hom}_R(Q_\bullet, N))$ of abelian groups induced by ψ_\bullet . Finally, $\varphi^* \circ \psi^* \sim \text{Id}$ and $\psi^* \circ \varphi^* \sim \text{Id}$ imply that $\overline{\varphi^*} \circ \overline{\psi^*} = \text{Id}$ and $\overline{\psi^*} \circ \overline{\varphi^*} = \text{Id}$. Therefore, $\overline{\varphi^*}$ and $\overline{\psi^*}$ are canonically defined isomorphisms. ■

Proposition 10.3 (Properties of Ext_R^n)

Let M, M_1, M_2 and N, N_1, N_2 be R -modules and let $n \in \mathbb{Z}_{>0}$ be an integer. The following holds:

(a) $\text{Ext}_R^0(M, N) \cong \text{Hom}_R(M, N)$.

(b) Any morphism of R -modules $\alpha : M_1 \rightarrow M_2$ induces a group homomorphism

$$\alpha^* : \text{Ext}_R^n(M_2, N) \rightarrow \text{Ext}_R^n(M_1, N).$$

(c) Any morphism of R -modules $\beta : N_1 \rightarrow N_2$ induces a group homomorphism

$$\beta_* : \text{Ext}_R^n(M, N_1) \rightarrow \text{Ext}_R^n(M, N_2).$$

(d) If P is a projective R -module, then $\text{Ext}_R^n(P, N) = 0$ for all $n \geq 1$.

(e) If I is an injective R -module, then $\text{Ext}_R^n(M, I) = 0$ for all $n \geq 1$.

Proof: (a) Let $P_\bullet \xrightarrow{\varepsilon} M$ be a projective resolution of M . Applying the left exact functor $\text{Hom}_R(-, N)$ to the resolution P_\bullet yields the cochain complex

$$\text{Hom}_R(P_0, N) \xrightarrow{d_1^*} \text{Hom}_R(P_1, N) \xrightarrow{d_2^*} \text{Hom}_R(P_2, N) \xrightarrow{d_3^*} \dots$$

Therefore,

$$\text{Ext}_R^0(M, N) = H^0(\text{Hom}_R(P_\bullet, N)) = \ker d_1^* / 0 \cong \ker d_1^*.$$

Now, the tail $\dots \xrightarrow{d_1} P_0 \xrightarrow{\varepsilon} M \rightarrow 0$ of the augmented complex $P_\bullet \xrightarrow{\varepsilon} M$ is an exact sequence of R -modules, so that the induced sequence

$$0 \longrightarrow \text{Hom}_R(M, N) \xrightarrow{\varepsilon^*} \text{Hom}_R(P_0, N) \xrightarrow{d_1^*} \dots$$

is exact at $\text{Hom}_R(M, N)$ and at $\text{Hom}_R(P_0, N)$ and it follows that

$$\text{Ext}_R^0(M, N) \cong \ker d_1^* = \text{Im } \varepsilon^* \cong \text{Hom}_R(M, N)$$

because ε^* is injective.

- (b) Let $P_\bullet \xrightarrow{\varepsilon} M_1$ be a projective resolution of M_1 and $P'_\bullet \xrightarrow{\varepsilon'} M_2$ be a projective resolution of M_2 . The Lifting Theorem implies that α lifts to a chain map $\varphi_\bullet : P_\bullet \rightarrow P'_\bullet$. Then, φ_\bullet induces a morphism of chain complexes $\varphi^* : \text{Hom}_R(P'_\bullet, N) \rightarrow \text{Hom}_R(P_\bullet, N)$ and then φ^* induces a morphism in cohomology

$$\overline{\varphi^*} : \text{Ext}_R^n(M_2, N) \rightarrow \text{Ext}_R^n(M_1, N)$$

for each $n \geq 0$ and we set $\alpha^* := \overline{\varphi^*}$.

- (c) Let $P_\bullet \xrightarrow{\varepsilon} M$ be a projective resolution of M . Then, there is a morphism of cochain complexes $\beta^\bullet : \text{Hom}_R(P_\bullet, N_1) \rightarrow \text{Hom}_R(P_\bullet, N_2)$ induced by β , which, in turn, induces a homomorphism of abelian groups β_* in cohomology.
- (d) Let $P_\bullet \xrightarrow{\varepsilon} M$ be a projective resolution of M . Choose $\dots \rightarrow 0 \rightarrow 0 \rightarrow P$ as a projective resolution of P (i.e. $P_0 := P, P_1 = 0, \dots$), augmented by the identity morphism $\text{Id}_P : P \rightarrow P$. Then the induced cochain complex is

$$\text{Hom}_R(P, N) \xrightarrow{0} 0 \xrightarrow{0} 0 \xrightarrow{0} \dots,$$

so that clearly $\text{Ext}_R^n(P, N) = 0$ for each $n \geq 1$.

- (e) Let $P_\bullet \xrightarrow{\varepsilon} M$ be a projective resolution of M . Since I is injective, the functor $\text{Hom}_R(-, I)$ is exact. Therefore the induced cochain complex

$$\text{Hom}_R(P_0, I) \xrightarrow{d_1^*} \text{Hom}_R(P_1, I) \xrightarrow{d_2^*} \text{Hom}_R(P_2, I) \xrightarrow{d_3^*} \dots$$

is exact and its cohomology is zero. The claim follows. ■

Remark 10.4

Using the proposition one can prove that for every $n \in \mathbb{Z}_{\geq 0}$, $\text{Ext}_R^n(-, N) : {}_R\mathbf{Mod} \rightarrow \mathbf{Ab}$ is a contravariant additive functor, and $\text{Ext}_R^n(M, -) : {}_R\mathbf{Mod} \rightarrow \mathbf{Ab}$ is a covariant additive functor.

Theorem 10.5 (Long exact sequences of Ext-groups)

- (a) Any s.e.s. $0 \rightarrow N_1 \xrightarrow{\varphi} N_2 \xrightarrow{\psi} N_3 \rightarrow 0$ of R -modules induces a long exact sequence of abelian groups

$$\begin{aligned} 0 &\rightarrow \text{Ext}_R^0(M, N_1) \xrightarrow{\varphi_*} \text{Ext}_R^0(M, N_2) \xrightarrow{\psi_*} \text{Ext}_R^0(M, N_3) \xrightarrow{\delta^0} \text{Ext}_R^1(M, N_1) \rightarrow \dots \\ \dots &\rightarrow \text{Ext}_R^n(M, N_1) \xrightarrow{\varphi_*} \text{Ext}_R^n(M, N_2) \xrightarrow{\psi_*} \text{Ext}_R^n(M, N_3) \xrightarrow{\delta^n} \text{Ext}_R^{n+1}(M, N_1) \rightarrow \dots \end{aligned}$$

- (b) Any s.e.s. $0 \rightarrow M_1 \xrightarrow{\alpha} M_2 \xrightarrow{\beta} M_3 \rightarrow 0$ of R -modules induces a long exact sequence of abelian groups

$$\begin{aligned} 0 &\rightarrow \text{Ext}_R^0(M_3, N) \xrightarrow{\beta^*} \text{Ext}_R^0(M_2, N) \xrightarrow{\alpha^*} \text{Ext}_R^0(M_1, N) \xrightarrow{\delta^1} \text{Ext}_R^1(M_3, N) \rightarrow \dots \\ \dots &\rightarrow \text{Ext}_R^n(M_3, N) \xrightarrow{\beta^*} \text{Ext}_R^n(M_2, N) \xrightarrow{\alpha^*} \text{Ext}_R^n(M_1, N) \xrightarrow{\delta^n} \text{Ext}_R^{n+1}(M_3, N) \rightarrow \dots \end{aligned}$$

Proof: (a) Let P_\bullet be a projective resolution of M . Then there is an induced short exact sequence of cochain complexes

$$0 \longrightarrow \text{Hom}_R(P_\bullet, N_1) \xrightarrow{\varphi^\bullet} \text{Hom}_R(P_\bullet, N_2) \xrightarrow{\psi^\bullet} \text{Hom}_R(P_\bullet, N_3) \longrightarrow 0$$

because each module P_n is projective. Indeed, at each degree $n \in \mathbb{Z}_{\geq 0}$ this sequence is

$$0 \longrightarrow \text{Hom}_R(P_n, N_1) \xrightarrow{\varphi_*} \text{Hom}_R(P_n, N_2) \xrightarrow{\psi_*} \text{Hom}_R(P_n, N_3) \longrightarrow 0$$

obtained by applying the functor $\text{Hom}_R(P_n, -)$, which is exact as P_n is projective. It is then easily checked that this gives a s.e.s. of cochain complexes, that is that the induced differential maps commute with the induced homomorphisms φ_* . Thus, applying Theorem 8.13 yields the required long exact sequence in cohomology.

(b) Let P_\bullet be a projective resolution of M_1 and let Q_\bullet be a projective resolution of M_3 . By the Horseshoe Lemma (Lemma 9.5), there exists a projective resolution R_\bullet of M_2 and a short exact sequence of chain complexes

$$0 \longrightarrow P_\bullet \longrightarrow R_\bullet \longrightarrow Q_\bullet \longrightarrow 0,$$

lifting the initial s.e.s. of R -modules. Since Q_n is projective for each $n \geq 0$, the sequences

$$0 \longrightarrow P_n \longrightarrow R_n \longrightarrow Q_n \longrightarrow 0$$

are split exact for each $n \geq 0$. Therefore applying $\text{Hom}_R(-, N)$ yields a split exact s.e.s.

$$0 \longrightarrow \text{Hom}_R(Q_n, N) \longrightarrow \text{Hom}_R(R_n, N) \longrightarrow \text{Hom}_R(P_n, N) \longrightarrow 0$$

for each $n \geq 0$. It follows that there is a s.e.s. of cochain complexes

$$0 \longrightarrow \text{Hom}_R(Q_\bullet, N) \longrightarrow \text{Hom}_R(R_\bullet, N) \longrightarrow \text{Hom}_R(P_\bullet, N) \longrightarrow 0.$$

The associated long exact sequence in cohomology (Theorem 8.13) is the required long exact sequence. ■

The above results show that the Ext groups “measure” and “repair” the non-exactness of the functors $\text{Hom}_R(M, -)$ and $\text{Hom}_R(-, N)$.

The next result is called “dimension-shifting” in the literature (however, it would be more appropriate to call it “degree-shifting”); it provides us with a method to compute Ext-groups by induction.

Remark 10.6 (Dimension shifting)

Let N be an R -module and consider a s.e.s.

$$0 \longrightarrow L \xrightarrow{\alpha} P \xrightarrow{\beta} M \longrightarrow 0$$

of R -modules, where P is projective (if M is given, take e.g. P free mapping onto M , with kernel L). Then $\text{Ext}_R^n(P, N) = 0$ for all $n \geq 1$ and applying the long exact sequence of Ext-groups yields at each degree $n \geq 1$ an exact sequence of the form

$$0 \xrightarrow{\alpha^*} \text{Ext}_R^n(L, N) \xrightarrow{\delta^n} \text{Ext}_R^{n+1}(M, N) \xrightarrow{\beta^*} 0,$$

where the connecting homomorphism δ^n is therefore forced to be an isomorphism:

$$\text{Ext}_R^{n+1}(M, N) \cong \text{Ext}_R^n(L, N).$$

Note that the same method applies to the second variable with a short exact sequence whose middle term is injective.

A consequence of the dimension shifting argument is that it allows us to deal with direct sums and products of modules in each variable of the Ext-groups. For this we need the following lemma:

Lemma 10.7

Consider the following commutative diagram of R -modules with exact rows:

$$\begin{array}{ccccccc} A' & \xrightarrow{\alpha} & A & \xrightarrow{\beta} & A'' & \longrightarrow & 0 \\ f \downarrow & & g \downarrow & & & & \\ B' & \xrightarrow{\varphi} & B & \xrightarrow{\psi} & B'' & \longrightarrow & 0 \end{array}$$

Then there exists a morphism $h \in \text{Hom}_R(A'', B'')$ such that $h \circ \beta = \psi \circ g$. Moreover, if f and g are isomorphisms, then so is h .

Proof: Exercise 5, Exercise Sheet 7. ■

Proposition 10.8 (Ext and direct sums)

(a) Let $\{M_i\}_{i \in I}$ be a family of R -modules and let N be an R -module. Then

$$\text{Ext}_R^n \left(\bigoplus_{i \in I} M_i, N \right) \cong \prod_{i \in I} \text{Ext}_R^n(M_i, N) \quad \forall n \geq 0.$$

(b) Let M be an R -module and let $\{N_i\}_{i \in I}$ be a family of R -modules. Then

$$\text{Ext}_R^n \left(M, \prod_{i \in I} N_i \right) \cong \prod_{i \in I} \text{Ext}_R^n(M, N_i) \quad \forall n \geq 0.$$

Proof: (a) **Case $n = 0$.** By Proposition 10.3(a) and the universal property of the direct sum (Proposition 4.2), we have

$$\text{Ext}_R^0 \left(\bigoplus_{i \in I} M_i, N \right) \cong \text{Hom}_R \left(\bigoplus_{i \in I} M_i, N \right) \cong \prod_{i \in I} \text{Hom}_R(M_i, N) \cong \prod_{i \in I} \text{Ext}_R^0(M_i, N).$$

Now, suppose that $n \geq 1$ and choose for each $i \in I$ a s.e.s. of R -modules

$$0 \longrightarrow L_i \longrightarrow P_i \longrightarrow M_i \longrightarrow 0,$$

where P_i is projective (e.g. choose P_i free with quotient isomorphic to M_i and kernel L_i). These sequences induce a s.e.s.

$$0 \longrightarrow \bigoplus_{i \in I} L_i \longrightarrow \bigoplus_{i \in I} P_i \longrightarrow \bigoplus_{i \in I} M_i \longrightarrow 0.$$

Case $n \geq 1$: We proceed by induction on n .

First, for $n=1$, using a long exact sequence of Ext-groups, we obtain a commutative diagram

$$\begin{array}{ccccccc} \text{Hom}_R(\bigoplus_{i \in I} P_i, N) & \longrightarrow & \text{Hom}_R(\bigoplus_{i \in I} L_i, N) & \xrightarrow{\delta^0} & \text{Ext}_R^1(\bigoplus_{i \in I} M_i, N) & \longrightarrow & \text{Ext}_R^1(\bigoplus_{i \in I} P_i, N) \\ \downarrow \cong & & \circlearrowleft & & \downarrow \cong & & \\ \prod_{i \in I} \text{Hom}_R(P_i, N) & \longrightarrow & \prod_{i \in I} \text{Hom}_R(L_i, N) & \longrightarrow & \prod_{i \in I} \text{Ext}_R^1(M_i, N) & \longrightarrow & \prod_{i \in I} \text{Ext}_R^1(P_i, N) \end{array}$$

with the following properties:

- the morphisms of the bottom row are induced componentwise;
- both rows are exact; and
- the two vertical isomorphisms are given by the case $n = 0$.

Since P_i is projective for every $i \in I$, so is $\bigoplus_{i \in I} P_i$, thus Proposition 10.3 yields

$$\text{Ext}_R^1\left(\bigoplus_{i \in I} P_i, N\right) \cong 0 \cong \prod_{i \in I} \text{Ext}_R^1(P_i, N) \quad \forall i \in I.$$

Therefore Lemma 10.7 yields

$$\text{Ext}_R^1\left(\bigoplus_{i \in I} M_i, N\right) \cong \prod_{i \in I} \text{Ext}_R^1(M_i, N).$$

Now assume that $n \geq 2$ and assume that the claim holds for the $(n - 1)$ -th Ext-groups, that is

$$\text{Ext}_R^{n-1}\left(\bigoplus_{i \in I} L_i, N\right) \cong \prod_{i \in I} \text{Ext}_R^{n-1}(L_i, N).$$

Then, applying the Dimension Shifting argument yields

$$\text{Ext}_R^{n-1}\left(\bigoplus_{i \in I} L_i, N\right) \cong \text{Ext}_R^n\left(\bigoplus_{i \in I} M_i, N\right).$$

and

$$\text{Ext}_R^{n-1}(L_i, N) \cong \text{Ext}_R^n(M_i, N) \quad \forall i \in I,$$

so that

$$\prod_{i \in I} \text{Ext}_R^{n-1}(L_i, N) \cong \prod_{i \in I} \text{Ext}_R^n(M_i, N).$$

Hence the required isomorphism

$$\text{Ext}_R^n\left(\bigoplus_{i \in I} M_i, N\right) \cong \prod_{i \in I} \text{Ext}_R^n(M_i, N).$$

- (b) Similar to (a): proceed by induction and apply a dimension shift. (In this case, we use s.e.s.'s with injective middle terms.) ■

To end this chapter, we introduce the Tor-groups, which “measure” the non-exactness of the functors $M \otimes_R -$ and $- \otimes_R N$.

Definition 10.9 (Tor-groups)

Let M be a right R -module and N be a left R -module. Let P_\bullet be a projective resolution of N . For $n \in \mathbb{Z}_{\geq 0}$, the n -th **Tor-group** of M and N is

$$\mathrm{Tor}_n^R(M, N) := H_n(M \otimes_R P_\bullet),$$

that is, the n -th homology group of the chain complex $M \otimes_R P_\bullet$.

Proposition 10.10

Let M, M_1, M_2, M_3 be right R -modules and let N, N_1, N_2, N_3 be left R -modules.

- (a) The group $\mathrm{Tor}_n^R(M, N)$ is independent of the choice of the projective resolution of N .
- (b) $\mathrm{Tor}_0^R(M, N) \cong M \otimes_R N$.
- (c) $\mathrm{Tor}_n^R(-, N)$ is an additive covariant functor.
- (d) $\mathrm{Tor}_n^R(M, -)$ is an additive covariant functor.
- (e) $\mathrm{Tor}_n^R(M_1 \oplus M_2, N) \cong \mathrm{Tor}_n^R(M_1, N) \oplus \mathrm{Tor}_n^R(M_2, N)$.
- (f) $\mathrm{Tor}_n^R(M, N_1 \oplus N_2) \cong \mathrm{Tor}_n^R(M, N_1) \oplus \mathrm{Tor}_n^R(M, N_2)$.
- (g) If either M or N is flat (so in particular if either M or N is projective), then $\mathrm{Tor}_n^R(M, N) = 0$ for all $n \geq 1$.
- (h) Any s.e.s. $0 \longrightarrow M_1 \xrightarrow{\alpha} M_2 \xrightarrow{\beta} M_3 \longrightarrow 0$ of right R -modules induces a long exact sequence

$$\begin{aligned} \cdots &\longrightarrow \mathrm{Tor}_{n+1}^R(M_3, N) \xrightarrow{\delta_{n+1}} \mathrm{Tor}_n^R(M_1, N) \xrightarrow{\alpha_*} \mathrm{Tor}_n^R(M_2, N) \xrightarrow{\beta_*} \mathrm{Tor}_n^R(M_3, N) \xrightarrow{\delta_n} \cdots \\ \cdots &\longrightarrow \mathrm{Tor}_1^R(M_3, N) \xrightarrow{\delta_1} M_1 \otimes_R N \xrightarrow{\alpha \otimes \mathrm{Id}_N} M_2 \otimes_R N \xrightarrow{\beta \otimes \mathrm{Id}_N} M_3 \otimes_R N \longrightarrow 0 \end{aligned}$$

of abelian groups.

- (i) Any s.e.s. $0 \longrightarrow N_1 \xrightarrow{\alpha} N_2 \xrightarrow{\beta} N_3 \longrightarrow 0$ of left R -modules induces a long exact sequence

$$\begin{aligned} \cdots &\longrightarrow \mathrm{Tor}_{n+1}^R(M, N_3) \xrightarrow{\delta_{n+1}} \mathrm{Tor}_n^R(M, N_1) \xrightarrow{\alpha_*} \mathrm{Tor}_n^R(M, N_2) \xrightarrow{\beta_*} \mathrm{Tor}_n^R(M, N_3) \xrightarrow{\delta_n} \cdots \\ \cdots &\longrightarrow \mathrm{Tor}_1^R(M, N_3) \xrightarrow{\delta_1} M \otimes_R N_1 \xrightarrow{\mathrm{Id}_M \otimes \alpha} M \otimes_R N_2 \xrightarrow{\mathrm{Id}_M \otimes \beta} M \otimes_R N_3 \longrightarrow 0 \end{aligned}$$

of abelian groups.

The proof of the above results are in essence similar to the proofs given for the Ext-groups.

From now on we assume that we are given a group (G, \cdot) (in multiplicative notation) and consider modules over the group algebra KG of G over a commutative ring K . The main aim of this chapter is to introduce the *cohomology groups* of G and describe concrete projective resolutions which shall allow use to compute them in some cases.

References:

- [Bro94] K. S. BROWN, *Cohomology of groups*, Graduate Texts in Mathematics, vol. 87, Springer-Verlag, New York, 1994.
- [Eve91] L. EVENS, *The cohomology of groups*, Oxford Mathematical Monographs, The Clarendon Press, Oxford University Press, New York, 1991.
- [Rot09] J. J. ROTMAN, *An introduction to the theory of groups. Fourth ed.*, Graduate Texts in Mathematics, vol. 148, Springer-Verlag, New York, 1995.
- [Wei94] C. A. WEIBEL, *An introduction to homological algebra*, Cambridge Studies in Advanced Mathematics, vol. 38, Cambridge University Press, Cambridge, 1994.

11 Modules over the Group Algebra

Lemma-Definition 11.1 (*Group algebra*)

If G is a group and K is a commutative ring, we may form the **group ring** KG whose elements are the formal linear combinations $\sum_{g \in G} \lambda_g g$ with $\lambda_g \in K$, and addition and multiplication are given by

$$\sum_{g \in G} \lambda_g g + \sum_{g \in G} \mu_g g = \sum_{g \in G} (\lambda_g + \mu_g) g \quad \text{and} \quad \left(\sum_{g \in G} \lambda_g g \right) \cdot \left(\sum_{h \in G} \mu_h h \right) = \sum_{g, h \in G} (\lambda_g \mu_h) gh.$$

Thus KG is a K -algebra, which as a K -module is free with basis G . Hence we usually call KG the **group algebra of G over K** rather than simply *group ring*.

Proof: By definition KG is a free K -module with basis G , and the multiplication in G is extended by K -bilinearity to the multiplication $KG \times KG \rightarrow KG$. It is then straightforward to check that this makes KG into a K -algebra. ■

In this lecture, we will mainly work with the following commutative rings: $K = \mathbb{Z}$ the ring of integers, and fields.

Remark 11.2**(a) KG -modules and representations:**

If K is a field, then specifying a KG -module V is the same thing as specifying a K -vector space V together with a K -linear action of G on V , i.e. a group homomorphism

$$G \longrightarrow \text{Aut}_K(V) =: GL(V),$$

or in other words a K -representation of G .

Similarly, if $K = \mathbb{Z}$, then specifying a $\mathbb{Z}G$ -module M is the same thing as specifying a \mathbb{Z} -module M together with a \mathbb{Z} -linear action of G on M , i.e. a group homomorphism

$$G \longrightarrow \text{Aut}_{\mathbb{Z}}(M)$$

also called an *integral representation* of G .

(b) Left and right KG -modules:

Since G is a group, the map $KG \longrightarrow KG$ such that $g \mapsto g^{-1}$ for each $g \in G$ is an anti-automorphism. It follows that any *left* KG -module M may be regarded as a *right* KG -module via the right G -action $m \cdot g := g^{-1}m$. Thus the sidedness of KG -modules is not usually an issue.

(c) The trivial KG -module:

The commutative ring K itself can be seen as a KG -module via the G -action

$$\begin{aligned} \cdot : G \times K &\longrightarrow K \\ (g, \lambda) &\longmapsto g \cdot \lambda := \lambda \end{aligned}$$

extended by K -linearity to the whole of KG . This module is called **the trivial KG -module**. An arbitrary KG -module A on which G acts trivially is also called a **trivial KG -module**.

(d) Tensor products of KG -modules:

If M and N are two KG -modules, then the tensor product $M \otimes_K N$ of M and N balanced over K can be made into a KG -module via the *diagonal action* of G , i.e.

$$g \cdot (m \otimes n) := gm \otimes gn \quad \forall g \in G, \forall m \in M, \forall n \in N.$$

(e) Morphisms of KG -modules:

If M and N are two KG -modules, then the abelian group $\text{Hom}_K(M, N)$ can be made into a KG -module via the *conjugation action* of G , i.e.

$$(g \cdot f)(m) := g \cdot f(g^{-1} \cdot m) \quad \forall g \in G, \forall m \in M.$$

(f) The augmentation map and the augmentation ideal:

The map $\varepsilon : KG \longrightarrow K$ defined by $\varepsilon(g) := 1$ for every $g \in G$ and extended by K -linearity to the whole of KG is called the **augmentation map**. This is a surjective homomorphism of K -algebras whose kernel

$$\ker(\varepsilon) =: IG$$

is called the **augmentation ideal** of KG , and $KG/IG \cong K$. (Notice that ε is hence also a homomorphism of KG -modules, so that we can also see IG as a KG -submodule of KG .)

Lemma 11.3

- (a) IG is a free K -module with K -basis $\{g - 1 \mid g \in G \setminus \{1\}\}$.
- (b) If X is a set of generators for the group G , then IG is generated as a KG -module by the set $\{x - 1 \mid x \in X\}$.
- (c) If M is a KG -module, then $IG \cdot M = \langle g \cdot m - m \mid g \in G, m \in M \rangle_K$.

Proof: (a) First of all, the set $S := \{g - 1 \mid g \in G \setminus \{1\}\}$ is clearly contained in $\ker \varepsilon$ by definition of ε . The set S is K -linearly independent since

$$\begin{aligned} 0 &= \sum_{g \in G \setminus \{1\}} \lambda_g (g - 1) \quad (\lambda_g \in K) \\ &= \sum_{g \in G \setminus \{1\}} \lambda_g g - \sum_{g \in G \setminus \{1\}} \lambda_g \end{aligned}$$

implies that $\lambda_g = 0$ for every $g \in G \setminus \{1\}$, because G is K -linearly independent in KG . To prove that S spans IG , let $\sum_{g \in G} \lambda_g g$ ($\lambda_g \in K$) be an element of $IG = \ker \varepsilon$. Hence

$$0 = \varepsilon\left(\sum_{g \in G} \lambda_g g\right) = \sum_{g \in G} \lambda_g$$

and it follows that

$$\sum_{g \in G} \lambda_g g = \sum_{g \in G} \lambda_g g - 0 = \sum_{g \in G} \lambda_g g - \sum_{g \in G} \lambda_g = \sum_{g \in G} \lambda_g (g - 1) = \sum_{g \in G \setminus \{1\}} \lambda_g (g - 1).$$

(b) Clearly, for every elements $g_1, g_2 \in G$ we have:

$$g_1 g_2 - 1 = g_1 (g_2 - 1) + (g_1 - 1) \quad \text{and} \quad g_1^{-1} - 1 = -g_1^{-1} (g_1 - 1)$$

Therefore $\{g - 1 \mid g \in G \setminus \{1\}\} \subseteq \langle \{x - 1 \mid x \in X\} \rangle_{KG}$, which implies that

$$IG = \langle \{g - 1 \mid g \in G \setminus \{1\}\} \rangle_K \subseteq \langle \{x - 1 \mid x \in X\} \rangle_{KG} \subseteq IG$$

and hence equality holds.

(c) Follows from (a). ■

Definition 11.4 (G -fixed points and G -cofixed points)

Let M be a KG -module.

- (a) The G -fixed points of M are by definition $M^G := \{m \in M \mid g \cdot m = m \forall g \in G\}$.
- (b) The G -cofixed points of M are by definition $M_G := M / (IG \cdot M)$.

Exercise [Exercise 1, Exercise Sheet 8]

Let M and N be KG -modules. Prove that:

- (a) M^G is the largest submodule of M on which G acts trivially;
- (b) M_G is the largest quotient of M on which G acts trivially;

- (c) $\text{Hom}_K(M, N)^G = \text{Hom}_{KG}(M, N)$;
 (d) $(M \otimes_K N)_G \cong M \otimes_{KG} N$;
 (e) If G is finite, then $(KG)^G = \langle \sum_{g \in G} g \rangle_K$ and if G is infinite, then $(KG)^G = 0$.

12 (Co)homology of Groups

We can eventually define the homology and cohomology groups of a given group G .

Definition 12.1 (Homology and cohomology of a group)

Let A be a KG -module and let $n \in \mathbb{Z}_{\geq 0}$. Define:

- (a) $H_n(G, A) := \text{Tor}_n^{KG}(K, A)$, the n -th homology group of G with coefficients in A ; and
 (b) $H^n(G, A) := \text{Ext}_{KG}^n(K, A)$, the n -th cohomology group of G with coefficients in A .

Remark 12.2

A priori the definition of the homology and cohomology groups $H_n(G, A)$ and $H^n(G, A)$ seem to depend on the base ring K , but in fact it is not the case. Indeed, it can be proven that there are group isomorphisms

$$\text{Tor}_n^{KG}(K, A) \cong \text{Tor}_n^{\mathbb{Z}G}(\mathbb{Z}, A)$$

and

$$\text{Ext}_{KG}^n(K, A) \cong \text{Ext}_{\mathbb{Z}G}^n(\mathbb{Z}, A)$$

for each $n \in \mathbb{Z}_{\geq 0}$ and every KG -module A , which can also be seen as a $\mathbb{Z}G$ -module via the unique ring homomorphism $\mathbb{Z} \rightarrow K$, mapping $1_{\mathbb{Z}}$ to 1_K . See Exercise 2, Exercise Sheet 8.

In view of the above remark, from now on, unless otherwise stated, we specify the ring K to \mathbb{Z} .

Proposition 12.3 (Long exact sequences)

Let $0 \rightarrow A \xrightarrow{\varphi} B \xrightarrow{\psi} C \rightarrow 0$ be a short exact sequence of $\mathbb{Z}G$ -modules. Then there are long exact sequences of abelian groups in homology and cohomology:

(a)

$$\begin{aligned} \dots &\rightarrow H_{n+1}(G, C) \xrightarrow{\delta_{n+1}} H_n(G, A) \xrightarrow{\varphi_*} H_n(G, B) \xrightarrow{\psi_*} H_n(G, C) \rightarrow \dots \\ \dots &\rightarrow H_1(G, C) \xrightarrow{\delta_1} H_0(G, A) \xrightarrow{\varphi_*} H_0(G, B) \xrightarrow{\psi_*} H_0(G, C) \rightarrow 0 \end{aligned}$$

(b)

$$\begin{aligned} 0 &\rightarrow H^0(G, A) \xrightarrow{\varphi_*} H^0(G, B) \xrightarrow{\psi_*} H^0(G, C) \xrightarrow{\delta^0} H^1(G, A) \rightarrow \dots \\ \dots &\rightarrow H^n(G, A) \xrightarrow{\varphi_*} H^n(G, B) \xrightarrow{\psi_*} H^n(G, C) \xrightarrow{\delta^n} H^{n+1}(G, A) \rightarrow \dots \end{aligned}$$

Proof: By definition of the homology and cohomology groups of G , (a) is a special case of Proposition 10.5(a) and (b) is a special case of Theorem 10.10(i). ■

To start our investigation we characterise the (co)homology of groups in degree zero:

Proposition 12.4

Let A be a $\mathbb{Z}G$ -module. Then

(a) $H_0(G, A) \cong \mathbb{Z} \otimes_{\mathbb{Z}G} A \cong A_G$, and

(b) $H^0(G, A) \cong \text{Hom}_{\mathbb{Z}G}(\mathbb{Z}, A) \cong A^G$

as abelian groups.

Proof:

(a) By Proposition 10.10(a), $H_0(G, A) = \text{Tor}_0^{\mathbb{Z}G}(\mathbb{Z}, A) \cong \mathbb{Z} \otimes_{\mathbb{Z}G} A$. Moreover by Exercise 1(d), Exercise Sheet 8, we have $\mathbb{Z} \otimes_{\mathbb{Z}G} A \cong (\mathbb{Z} \otimes_{\mathbb{Z}} A)_G \cong A_G$.

(b) We already know that $H^0(G, A) = \text{Ext}_{\mathbb{Z}G}^0(\mathbb{Z}, A) \cong \text{Hom}_{\mathbb{Z}G}(\mathbb{Z}, A)$. Moreover by Exercise 1(c), Exercise Sheet 8, we have $\text{Hom}_{\mathbb{Z}G}(\mathbb{Z}, A) \cong \text{Hom}_{\mathbb{Z}}(\mathbb{Z}, A)^G \cong A^G$. ■

The degree-one (co)homology groups with coefficients in a trivial $\mathbb{Z}G$ -module can also be characterised using the augmentation ideal. For this we let $G_{ab} := G/[G, G]$ denote the abelianization of the group G .

Exercise [Exercise 4, Exercise Sheet 8]

Prove that:

(a) There is an isomorphism of abelian groups $(IG/(IG)^2, +) \cong (G_{ab}, \cdot)$.

(b) If A is a trivial $\mathbb{Z}G$ -module, then:

· $H_1(G, A) \cong IG \otimes_{\mathbb{Z}G} A \cong IG/(IG)^2 \otimes_{\mathbb{Z}G} A \cong IG/(IG)^2 \otimes_{\mathbb{Z}} A \cong G_{ab} \otimes_{\mathbb{Z}} A$;

· $H^1(G, A) \cong \text{Hom}_{\mathbb{Z}G}(IG, A) \cong \text{Hom}_{\mathbb{Z}G}(IG/(IG)^2, A) \cong \text{Hom}_{\mathbb{Z}}(IG/(IG)^2, A) \cong \text{Hom}_{\mathbb{Z}}(G_{ab}, A) \cong \text{Hom}_{\text{Grp}}(G, A)$.

Corollary 12.5

If \mathbb{Z} denotes the trivial $\mathbb{Z}G$ -module, then $H_1(G, \mathbb{Z}) \cong IG/(IG)^2 \cong G_{ab}$.

Proof: This is straightforward from Exercise 4, Exercise Sheet 8. ■

13 The Bar Resolution

In order to compute the (co)homology of groups, we need *concrete* projective resolutions of \mathbb{Z} as a $\mathbb{Z}G$ -module.

Notation 13.1

Let $n \in \mathbb{Z}_{\geq 0}$ be a non-negative integer. Let F_n be the free \mathbb{Z} -module with \mathbb{Z} -basis consisting of all $(n+1)$ -tuples (g_0, g_1, \dots, g_n) of elements of G . Then the group G acts on F_n via

$$g \cdot (g_0, g_1, \dots, g_n) = (gg_0, gg_1, \dots, gg_n),$$

and it follows that F_n is a free $\mathbb{Z}G$ -module with $\mathbb{Z}G$ -basis $\mathcal{B}_n := \{(1, g_1, \dots, g_n) \mid g_i \in G\}$. First, for each $0 \leq i \leq n$, define maps

$$\begin{aligned} \partial_i: G^{n+1} &\longrightarrow G^n \\ (g_0, \dots, g_n) &\longmapsto (g_0, \dots, \check{g}_i, \dots, g_n), \end{aligned}$$

where the check notation means that g_i is deleted from the initial $(n+1)$ -tuple in order to produce an n -tuple, and extend them by \mathbb{Z} -linearity to the whole of F_n . If $n \geq 1$, define

$$\begin{aligned} d_n: F_n &\longrightarrow F_{n-1} \\ x &\longmapsto \sum_{i=0}^n (-1)^i \partial_i(x). \end{aligned}$$

Since the maps ∂_i are $\mathbb{Z}G$ -linear by definition, so is d_n . Finally consider the augmentation map

$$\begin{aligned} \varepsilon: F_0 = \mathbb{Z}G &\longrightarrow \mathbb{Z} \\ g &\longmapsto 1 \quad \forall g \in G. \end{aligned}$$

Proposition 13.2

The sequence $\dots \xrightarrow{d_{n+1}} F_n \xrightarrow{d_n} F_{n-1} \xrightarrow{d_{n-1}} \dots \xrightarrow{d_1} F_0$ is a free $\mathbb{Z}G$ -resolution of the trivial $\mathbb{Z}G$ -module.

Proof: Set $F_{-1} := \mathbb{Z}$ and $d_0 := \varepsilon$ (note that $\varepsilon = d_0$ is consistent with the definition of d_n). We have to prove that the resulting sequence

$$(F_\bullet, d_\bullet) \xrightarrow{\varepsilon} \mathbb{Z} := \left(\dots \xrightarrow{d_{n+1}} F_n \xrightarrow{d_n} F_{n-1} \xrightarrow{d_{n-1}} \dots \xrightarrow{d_1} F_0 \xrightarrow{d_0} F_{-1} \right)$$

is an exact complex.

• **Claim 1:** $d_{n-1} \circ d_n = 0$ for every $n \geq 1$.

Indeed: Let $(g_0, \dots, g_n) \in G^{n+1}$ be a basis element. Then

$$(d_{n-1} \circ d_n)(g_0, \dots, g_n) = \sum_{i=0}^{n-1} \sum_{j=0}^n (-1)^i (-1)^j (\partial_i \circ \partial_j)(g_0, \dots, g_n).$$

Now let $0 \leq i_0 < j_0 \leq n$. If we remove g_{j_0} first and then g_{i_0} , we get

$$(\partial_{i_0} \circ \partial_{j_0})(g_0, \dots, g_n) = (-1)^{i_0+j_0} (g_0, \dots, \check{g}_{i_0}, \dots, \check{g}_{j_0}, \dots, g_n).$$

On the other hand, if we remove g_{i_0} first, then g_{j_0} is shifted to position $j_0 - 1$ and must be removed with sign $(-1)^{j_0-1}$. So both terms cancel and it follows that $d_{n-1} \circ d_n$ is the zero map.

· **Claim 2:** $F_\bullet \xrightarrow{\varepsilon} \mathbb{Z}$ is an exact complex.

Indeed: by definition of the modules F_n ($n \geq 0$), we may view (F_\bullet, d_\bullet) as a complex of \mathbb{Z} -modules. By Exercise 3, Exercise Sheet 5, it suffices to prove that there exists a homotopy between Id_{F_\bullet} and the zero chain map. For $n \geq 0$, define

$$s_n : \begin{array}{ccc} F_n & \longrightarrow & F_{n+1} \\ (g_0, \dots, g_n) & \mapsto & (1, g_0, \dots, g_n), \end{array}$$

let $s_{-1} : \mathbb{Z} = F_{-1} \longrightarrow F_0 \cong \mathbb{Z}G$ be the \mathbb{Z} -homomorphism sending 1 to (1), and let $s_i := 0$ for all $i \leq -2$. For $n \geq 0$ and $(g_0, \dots, g_n) \in G^{n+1}$ compute

$$\begin{aligned} (d_{n+1} \circ s_n + s_{n-1} \circ d_n)(g_0, \dots, g_n) &= (g_0, \dots, g_n) + \sum_{j=1}^{n+1} (-1)^j (1, g_0, \dots, \check{g}_{j-1}, \dots, g_n) \\ &\quad + \sum_{i=0}^n (-1)^i (1, g_0, \dots, \check{g}_i, \dots, g_n) \\ &= (g_0, \dots, g_n), \end{aligned}$$

and it is clear that $d_{n+1} \circ s_n + s_{n-1} \circ d_n = \text{Id}_{F_n}$ for every $n \leq -1$, as required. ■

Notation 13.3 (Bar notation)

Given $n \in \mathbb{Z}_{\geq 0}$, set

$$[g_1|g_2|\dots|g_n] := (1, g_1, g_1g_2, g_1g_2g_3, \dots, g_1 \cdot \dots \cdot g_n) \in G^{n+1}.$$

With this notation, we have

$$(1, h_1, \dots, h_n) = [h_1|h_1^{-1}h_2|h_2^{-1}h_3|\dots|h_{n-1}^{-1}h_n].$$

Hence F_n becomes a free $\mathbb{Z}G$ -module with basis $\{[g_1|\dots|g_n] \mid g_i \in G\} =: \underline{G}^n$, which as a set is in bijection with G^n . In particular F_0 is the free $\mathbb{Z}G$ -module with basis $\{[\]\}$ (empty symbol). With this notation, for every $n \geq 1$ and every $0 \leq i \leq n$, we have

$$\partial_i [g_1|\dots|g_n] = \begin{cases} g_1 \cdot [g_2|\dots|g_n] & i = 0, \\ [g_1|\dots|g_{i-1}|g_i g_{i+1}|g_{i+2}|\dots|g_n] & 1 \leq i \leq n-1, \\ [g_1|\dots|g_{n-1}] & i = n. \end{cases}$$

Because of this notation the resolution of Proposition 13.2 is known as the **bar resolution**.

In fact, it is possible to render computations easier, by considering a slight alteration of the bar resolution called the **normalised bar resolution**.

Notation 13.4 (The normalised bar notation)

Let $n \in \mathbb{Z}_{\geq 0}$, and let F_n be as above and let D_n be the $\mathbb{Z}G$ -submodule of F_n generated by all elements $[g_1|\dots|g_n]$ of F_n such that at least one of the coefficients g_i is equal to 1. In other words, if $(1, h_1, \dots, h_n) \in F_n$, then:

$$(1, h_1, \dots, h_n) \in D_n \iff \exists 1 \leq i \leq n-1 \text{ such that } h_i = h_{i+1}.$$

Lemma 13.5

- (a) D_\bullet is a subcomplex of F_\bullet .
- (b) $s_n(D_n) \subset D_{n+1}$ for all $n \geq 0$.

Proof:

- (a) Let $n \geq 1$. We have to prove that $d_n(D_n) \subseteq D_{n-1}$. So let $(1, h_1, \dots, h_n) \in D_n$, so that there is an index $1 \leq i \leq n - 1$ such that $h_i = h_{i+1}$. Then, clearly

$$\partial_j(1, h_1, \dots, h_n) \in D_{n-1} \quad \text{for each } 0 \leq j \leq n \text{ such that } j \neq i, i + 1.$$

On the other hand, we have the equality $\partial_i(1, h_1, \dots, h_n) = \partial_{i+1}(1, h_1, \dots, h_n)$ and in the alternating sum $d_n(1, h_1, \dots, h_n) = \sum_{i=0}^n (-1)^i \partial_i(1, h_1, \dots, h_n)$, the signs of ∂_i and ∂_{i+1} are opposite to each other. Therefore, we are left with a sum over $j \neq i, i + 1$.

- (b) Obvious by definition of s_n . ■

Corollary 13.6

Set $\bar{F}_n := F_n/D_n$ for every $n \geq 0$. Then \bar{F}_\bullet is a free $\mathbb{Z}G$ -resolution of the trivial module.

Proof: Since D_\bullet is a subcomplex of F_\bullet , we can form the quotient complex $(\bar{F}_\bullet, \bar{d}_\bullet)$, which consists of free $\mathbb{Z}G$ -modules. Now by the Lemma, $s_n(D_n) \subset D_{n+1}$ for each $n \geq 0$, therefore D_n is in the kernel of s_n post-composed with the quotient map $F_{n+1} \rightarrow F_{n+1}/D_{n+1}$ and each \mathbb{Z} -linear map $s_n : F_n \rightarrow F_{n+1}$ induces a \mathbb{Z} -linear maps $\bar{s}_n : \bar{F}_n \rightarrow \bar{F}_{n+1}$ via the Universal Property of the quotient. Hence, similarly to the proof of Proposition 13.2, we get a homotopy $\{\bar{s}_n \mid n \in \mathbb{Z}\}$ and we conclude that the sequence

$$\dots \longrightarrow \bar{F}_n \xrightarrow{\bar{d}_n} \bar{F}_{n-1} \longrightarrow \dots \xrightarrow{\bar{d}_1} \bar{F}_0 \xrightarrow{\bar{\varepsilon}=\bar{d}_0} \mathbb{Z} \longrightarrow 0.$$

is exact, as required. ■

Definition 13.7 (Normalised bar resolution)

The chain complex $(\bar{F}_\bullet, \bar{d}_\bullet)$ is called the **normalised bar resolution** of \mathbb{Z} as a $\mathbb{Z}G$ -module.

Example 9 (Bar resolution in low degrees)

In low degrees the bar resolution has the form

$$\begin{array}{ccccccc} \dots & \longrightarrow & F_2 & \xrightarrow{d_2} & F_1 & \xrightarrow{d_1} & F_0 \xrightarrow{\varepsilon} \mathbb{Z} \longrightarrow 0 \\ \text{bases elts:} & & [g_1|g_2] & & [g] & & [] \end{array}$$

with

- $\varepsilon([]) = 1$;
- $d_1([g]) = \partial_0([g]) - \partial_1([g]) = g[] - []$;
- $d_2[g_1|g_2] = \partial_0([g_1|g_2]) - \partial_1([g_1|g_2]) + \partial_2([g_1|g_2]) = g_1[g_2] - [g_1g_2] + [g_1]$.

Similar formulae hold for \bar{F}_\bullet . (Exercise!)

14 Cocycles and Coboundaries

We now use the (normalised) bar resolution in order to compute the cohomology groups $H^n(G, A)$ ($n \geq 0$), where A is an arbitrary $\mathbb{Z}G$ -module. To this end, we need to consider the cochain complex $\text{Hom}_{\mathbb{Z}G}(F_\bullet, A)$. Define

$$C^n(G, A) := \text{Hom}_{\text{Set}}(\underline{G}^n, A)$$

to be the set of all maps from \underline{G}^n to A , so that clearly there is an isomorphism of \mathbb{Z} -modules

$$\text{Hom}_{\mathbb{Z}G}(F_n, A) \xrightarrow{\cong} C^n(G, A)$$

mapping $f \mapsto f|_{\underline{G}^n}$. Using this isomorphism, we see that the corresponding differential maps are:

$$\begin{aligned} d_n^* : C^{n-1}(G, A) &\longrightarrow C^n(G, A) \\ f &\longmapsto d_n^*(f) \end{aligned}$$

where

$$\begin{aligned} d_n^*(f)([g_1 | \dots | g_n]) &= f(g_1[g_2 | \dots | g_n]) + \sum_{i=1}^{n-1} (-1)^i f([g_1 | \dots | g_i g_{i+1} | \dots | g_n]) \\ &\quad + (-1)^n f([g_1 | \dots | g_{n-1}]). \end{aligned}$$

Definition 14.1 (*n-cochains, n-cocycles, n-coboundaries*)

With the above notation:

- (a) The elements of $C^n(G, A)$ are called the *n-cochains* of G .
- (b) If $f \in C^n(G, A)$ is such that $d_{n+1}^* f = 0$, then f is called an *n-cocycle* of G , and the set of all *n-cocycles* is denoted $Z^n(G, A)$.
- (c) If $f \in C^n(G, A)$ is in the image of $d_n^* : C^{n-1}(G, A) \longrightarrow C^n(G, A)$, then f is called an *n-coboundary* of G . We denote by $B^n(G, A)$ the set of all *n-coboundaries*.

Proposition 14.2

Let A be a $\mathbb{Z}G$ -module and $n \geq 0$. Then $H^n(G, A) \cong Z^n(G, A)/B^n(G, A)$.

Proof: Compute cohomology via the bar resolution and replace the \mathbb{Z} -module $\text{Hom}_{\mathbb{Z}G}(F_n, A)$ by its isomorphic \mathbb{Z} -module $C^n(G, A)$. The claim follows. ■

Remark 14.3

If we used the normalised bar resolution instead, the *n-cochains* are replaced by the *n-cochains* vanishing on *n*-tuples $[g_1 | \dots | g_n]$ having (at least) one of coefficient g_i equal to 1. (This is because $\text{Hom}_{\mathbb{Z}G}(\overline{F}_n, A) \subset \text{Hom}_{\mathbb{Z}G}(F_n, A)$). We denote these by $\overline{C}^n(G, A)$, and thus $\overline{C}^n(G, A) \subseteq C^n(G, A)$. The set of resulting normalised *n-cocycles* is denoted by $\overline{Z}^n(G, A)$, and the set of resulting normalised *n-coboundaries* by $\overline{B}^n(G, A)$. It follows that

$$H^n(G, A) \cong Z^n(G, A)/B^n(G, A) \cong \overline{Z}^n(G, A)/\overline{B}^n(G, A).$$

In this short chapter we consider some cases in which the cohomology groups of a group G have an easy interpretation. This is for example the case in low degrees (zero, one, two). Next we consider families of groups whose cohomology groups are easy to compute with the methods we have so far at our disposal.

References:

- [Bro94] K. S. BROWN, *Cohomology of groups*, Graduate Texts in Mathematics, vol. 87, Springer-Verlag, New York, 1994.
- [Eve91] L. EVENS, *The cohomology of groups*, Oxford Mathematical Monographs, The Clarendon Press, Oxford University Press, New York, 1991.
- [Rot09] J. J. ROTMAN, *An introduction to the theory of groups. Fourth ed.*, Graduate Texts in Mathematics, vol. 148, Springer-Verlag, New York, 1995.
- [Wei94] C. A. WEIBEL, *An introduction to homological algebra*, Cambridge Studies in Advanced Mathematics, vol. 38, Cambridge University Press, Cambridge, 1994.

15 Low-degree Cohomology

A. Degree-zero cohomology.

We have already proved in Proposition 12.4 that $H^0(G, A) \cong A^G$, the G -fixed points of A . In particular, if A is a trivial $\mathbb{Z}G$ -module, then $H^0(G, A) = A$.

B. Degree-one cohomology.

Using the bar resolution to compute $H^1(G, A)$ yields $H^1(G, A) = Z^1(G, A)/B^1(G, A)$.

1-cocycles: By definition, and the description of the differential maps of the bar resolution, we have

$$\begin{aligned} Z^1(G, A) &= \{f \in \text{Hom}_{\text{Set}}(\underline{G}^1, A) \mid d_2^*(f) = 0\} \\ &= \{f \in \text{Hom}_{\text{Set}}(\underline{G}^1, A) \mid 0 = f(g_1[g_2]) - f([g_1g_2]) + f([g_1]) \ \forall [g_1|g_2] \in \underline{G}^2\} \end{aligned}$$

In other words, a map $f : G \rightarrow A$ is a 1-cocycle if and only if it satisfies the

1-cocycle identity: $f(g_1 \cdot g_2) = g_1 \cdot f(g_2) + f(g_1) \quad \forall g_1, g_2 \in G$.

1-coboundaries: $C^0(G, A) = \text{Hom}_{\text{Set}}(\{[]\}, A) = \{f_a : \{[]\} \rightarrow A, [] \mapsto a \mid a \in A\} \xrightarrow{\text{bij.}} A$. It follows that the differential map

$$d_1^* : C^0(G, A) \rightarrow C^1(G, A)$$

is such that $d_1^*(f_a)(g) = f_a(g[]) - f_a([]) = ga - a$ for every $g \in G$ and every $a \in A$. Therefore, $f : G \rightarrow A$ is a 1-coboundary if and only if there exists $a \in A$ such that $f(g) = ga - a$ for every $g \in G$.

Definition 15.1 (Derivation, principal derivation)

Let A be a $\mathbb{Z}G$ -module and let $f : G \rightarrow A$ be a map.

- (a) If f satisfies the 1-cocycle identity, then it is called a **derivation** of G . We denote by $\text{Der}(G, A)$ the set of all derivations of G to A .
- (b) If, moreover, there exists $a \in A$ such that $f(g) = ga - a$ for every $g \in G$, then f is called a **principal derivation** (or an **inner derivation**) of G . We denote by $\text{Inn}(G, A)$ the set of all inner derivations of G to A .

Remark 15.2

It follows from the above that $H^1(G, A) \cong Z^1(G, A)/B^1(G, A) = \text{Der}(G, A)/\text{Inn}(G, A)$.

Example 10

Let A be a trivial $\mathbb{Z}G$ -module. In this case, the 1-cocycle identity becomes

$$f(g \cdot h) = f(g) + f(h),$$

so that $Z^1(G, A) = \text{Hom}_{\text{Grp}}((G, \cdot), (A, +))$. Furthermore $B^1(G, A) = 0$. Therefore

$$H^1(G, A) = \text{Hom}_{\text{Grp}}((G, \cdot), (A, +)).$$

C. Degree-two cohomology.

Again using the bar resolution to compute $H^2(G, A)$ yields $H^2(G, A) = Z^2(G, A)/B^2(G, A)$.

2-cocycles: By definition, and the description of the differential maps of the bar resolution, we have

$$\begin{aligned} Z^2(G, A) &= \{f \in \text{Hom}_{\text{Set}}(\underline{G}^2, A) \mid d_3^*(f) = 0\} \\ &= \{f \in \text{Hom}_{\text{Set}}(\underline{G}^2, A) \mid 0 = f(g_1[g_2|g_3]) - f([g_1g_2|g_3]) \\ &\quad + f([g_1|g_2g_3]) - f([g_1|g_2]) \forall [g_1|g_2|g_3] \in \underline{G}^3\} \end{aligned}$$

In other words, a map $f : G \times G \rightarrow A$ is a 2-cocycle if and only if it satisfies the

$$\boxed{\text{2-cocycle identity: } g_1f(g_2, g_3) + f(g_1, g_2g_3) = f(g_1g_2, g_3) + f(g_1, g_2) \quad \forall g_1, g_2, g_3 \in G.}$$

2-coboundaries: If $\phi \in C^1(G, A)$, then

$$d_2^*(\phi)([g_1|g_2]) = \phi(g_1[g_2]) - \phi([g_1g_2]) + \phi([g_1]) \quad \forall [g_1|g_2] \in \underline{G}^2.$$

Therefore a map $f : G \times G \rightarrow A$ is a 2-coboundary if and only if there exists a map $c : G \rightarrow A$ such that

$$f(g_1, g_2) = g_1 c(g_2) - c(g_1g_2) + c(g_1) \quad \forall g_1, g_2 \in G.$$

16 Cohomology of Cyclic Groups

Cyclic groups, finite and infinite, are a family of groups, for which cohomology is easy to compute. Of course, we could use the bar resolution, but it turns out that in this case, there is a more efficient resolution to be used, made up of free modules of rank 1.

Notation: If A is a $\mathbb{Z}G$ -module and $x \in \mathbb{Z}G$, then we let $m_x : A \rightarrow A, x \mapsto x \cdot a$ denote the left action of x on A (or left external multiplication by x in A).

Proposition 16.1 (Free resolution of finite cyclic groups)

Let C_n be a finite cyclic group of order $n \in \mathbb{Z}_{>0}$ generated by g , and let $t := \sum_{i=0}^{n-1} g^i \in \mathbb{Z}C_n$. Then

$$\cdots \xrightarrow{m_t} \mathbb{Z}C_n \xrightarrow{m_{g-1}} \mathbb{Z}C_n \xrightarrow{m_t} \mathbb{Z}C_n \xrightarrow{m_{g-1}} \mathbb{Z}C_n,$$

is a free $\mathbb{Z}C_n$ -resolution of the trivial $\mathbb{Z}C_n$ -module.

Proof: Set $G := C_n$. By Lemma 11.3,

$$IG = \langle \{g^i - 1 \mid 1 \leq i \leq n-1\} \rangle_{\mathbb{Z}} = \langle g-1 \rangle_{\mathbb{Z}G}.$$

Therefore, the image of m_{g-1} is equal to IG , which is the kernel of the augmentation map $\varepsilon : \mathbb{Z}G \rightarrow \mathbb{Z}$.

Now, let $x = \sum_{i=0}^{n-1} \lambda_i g^i \in \mathbb{Z}G$. Then, $tx = \sum_{i=0}^{n-1} \lambda_i t$. Hence

$$\ker(m_t) = \left\{ \sum_{i=0}^{n-1} \lambda_i g^i \mid \sum_{i=0}^{n-1} \lambda_i = 0 \right\}$$

and we claim that this is equal to the image of m_{g-1} . Indeed, the inclusion $\text{Im}(m_{g-1}) \subseteq \ker(m_t)$ is clear, and conversely, if $h = \sum_{i=0}^{n-1} \lambda_i g^i \in \ker(m_t)$, then $\sum_{i=0}^{n-1} \lambda_i = 0$, so that $h \in \ker(\varepsilon) = IG = \text{Im}(m_{g-1})$,

whence $\ker(m_t) \subseteq \text{Im}(m_{g-1})$. Finally, we claim that $\ker(m_{g-1}) = \text{Im}(m_t)$. We have

$$\begin{aligned} \sum_{i=0}^{n-1} \lambda_i g^i \in \ker(m_{g-1}) &\iff (g-1) \left(\sum_{i=0}^{n-1} \lambda_i g^i \right) = 0 \\ &\iff \sum_{i=0}^{n-1} \lambda_i g^{i+1} - \sum_{i=0}^{n-1} \lambda_i g^i = 0 \\ &\iff \sum_{j=0}^{n-1} \lambda_{j-1} g^j - \sum_{i=0}^{n-1} \lambda_i g^i = 0, \text{ where } \lambda_1 := \lambda_{n-1} \\ &\iff \sum_{i=0}^{n-1} (\lambda_{i-1} - \lambda_i) g^i = 0 \\ &\iff \forall 0 \leq i \leq n-1, \lambda_{i-1} = \lambda_i =: \lambda \\ &\iff \sum_{i=0}^{n-1} \lambda_i g^i = \lambda t \iff \sum_{i=0}^{n-1} \lambda_i g^i \in \text{Im}(m_t). \end{aligned}$$

Theorem 16.2 (Cohomology of finite cyclic groups)

Let $C_n = \langle g \mid g^n = 1 \rangle$ be a finite cyclic group of order $n \in \mathbb{Z}_{>0}$ and let A be a $\mathbb{Z}C_n$ -module. Then

$$H^m(C_n, A) \cong \begin{cases} A^{C_n} & \text{if } m = 0, \\ A^{C_n} / \text{Im}(m_t) & \text{if } m \geq 2, m \text{ even,} \\ \ker(m_t) / \text{Im}(m_{g-1}) & \text{if } m \geq 1, m \text{ odd,} \end{cases}$$

where $t = \sum_{i=0}^{n-1} g^i \in \mathbb{Z}C_n$ and for $x \in \{t, g-1\}$, m_x denotes left external multiplication by x in A .

Proof: By Proposition 16.1 the trivial $\mathbb{Z}G$ -module \mathbb{Z} admits the projective resolution

$$\dots \xrightarrow{m_t} \mathbb{Z}C_n \xrightarrow{m_{g-1}} \mathbb{Z}C_n \xrightarrow{m_t} \mathbb{Z}C_n \xrightarrow{m_{g-1}} \mathbb{Z}C_n \dots$$

For $m = 0$, we already know that $H^0(C_n, A) = A^{C_n}$. For $m > 0$, applying the functor $\text{Hom}_{\mathbb{Z}C_n}(-, A)$ yields the cochain complex

$$\text{Hom}_{\mathbb{Z}C_n}(\mathbb{Z}C_n, A) \xrightarrow{m_{g-1}^*} \text{Hom}_{\mathbb{Z}C_n}(\mathbb{Z}C_n, A) \xrightarrow{m_t^*} \text{Hom}_{\mathbb{Z}C_n}(\mathbb{Z}C_n, A) \xrightarrow{m_{g-1}^*} \dots,$$

where in each degree there is an isomorphism $\text{Hom}_{\mathbb{Z}C_n}(\mathbb{Z}C_n, A) \xrightarrow{\cong} A, f \mapsto f(1)$. Hence for $x \in \{g-1, t\}$, there are commutative diagrams of the form

$$\begin{array}{ccc} \text{Hom}_{\mathbb{Z}C_n}(\mathbb{Z}C_n, A) & \xrightarrow{m_x^*} & \text{Hom}_{\mathbb{Z}C_n}(\mathbb{Z}C_n, A) \\ \downarrow \cong & \circlearrowleft & \downarrow \cong \\ A & \xrightarrow{m_x} & A \end{array}$$

Hence, the initial cochain complex is isomorphic to the cochain complex

$$\begin{array}{cccc} A & \xrightarrow{m_{g-1}} & A & \xrightarrow{m_t} & A & \xrightarrow{m_{g-1}} & A & \xrightarrow{m_t} & \dots \\ \text{(degree)} & 0 & 1 & 2 & 3 & & & & \end{array}$$

and the claim follows. ■

For infinite cyclic groups the situation is even simpler:

Theorem 16.3 (Cohomology of infinite cyclic groups)

If $G = \langle g \rangle$ is an infinite cyclic group, then $0 \longrightarrow \mathbb{Z}G \xrightarrow{m_{g-1}} \mathbb{Z}G$ is a free resolution of the trivial $\mathbb{Z}G$ -module, and

$$H^n(G, A) = \begin{cases} A^G & \text{if } n = 0, \\ A/\text{Im}(m_{g-1}) & \text{if } n = 1, \\ 0 & \text{if } n \geq 2. \end{cases}$$

where m_{g-1} denotes the left external multiplication by $g - 1$ in A .

Proof: Exercise 1, Exercise Sheet 9. ■

Chapter 6. Cohomology and Group Extensions

In this chapter we consider connections between the short exact sequences of groups of the form $1 \rightarrow A \rightarrow E \rightarrow G \rightarrow 1$ with abelian kernel and the cohomology of the group G with coefficients in A . If the sequence splits, then we shall prove that the 1st cohomology group $H^1(G, A)$ parametrises the splittings. Moreover, we shall also prove that the 2nd cohomology group $H^2(G, A)$ is in bijection with the isomorphism classes of extensions $1 \rightarrow A \rightarrow E \rightarrow G \rightarrow 1$ inducing the given $\mathbb{Z}G$ -module structure on A , and the neutral element of $H^2(G, A)$ corresponds, under this bijection, to a s.e.s. where E is a semi-direct product of A by G .

References:

- [Bro94] K. S. BROWN, *Cohomology of groups*, Graduate Texts in Mathematics, vol. 87, Springer-Verlag, New York, 1994.
- [Eve91] L. EVENS, *The cohomology of groups*, Oxford Mathematical Monographs, The Clarendon Press, Oxford University Press, New York, 1991.
- [Rot09] J. J. ROTMAN, *An introduction to the theory of groups. Fourth ed.*, Graduate Texts in Mathematics, vol. 148, Springer-Verlag, New York, 1995.
- [Wei94] C. A. WEIBEL, *An introduction to homological algebra*, Cambridge Studies in Advanced Mathematics, vol. 38, Cambridge University Press, Cambridge, 1994.

17 Group Extensions

In Chapter 1, we have seen that if a group G is a semi-direct product of a subgroup N by a subgroup H , then this gives rise to a s.e.s. of the form

$$1 \rightarrow N \rightarrow G \rightarrow H \rightarrow 1.$$

This is a special case of a so-called *group extension of N by H* .

Definition 17.1 (Group extension)

A **group extension** is a short exact sequence of groups (written multiplicatively) of the form

$$1 \longrightarrow A \xrightarrow{i} E \xrightarrow{p} G \longrightarrow 1,$$

and, in this situation, we also say that the group E is an **extension of A by G** .

Convention: We shall always identify A with a normal subgroup of E and assume that i is simply

the canonical inclusion of A in E . Moreover, we shall say that A is the **kernel** of the extension.

Lemma 17.2

Let $1 \longrightarrow A \xrightarrow{i} E \xrightarrow{p} G \longrightarrow 1$ be a group extension, where A is an abelian group. Then A is naturally endowed with the structure of a $\mathbb{Z}G$ -module.

Proof: First note that with the above notation (A, \cdot) is a group written multiplicatively. Next, for each $g \in G$, choose a preimage $\tilde{g} \in E$ of g under p , that is $p(\tilde{g}) = g$, and define a left G -action on A via:

$$\begin{aligned} * : G \times A &\longrightarrow A \\ (g, a) &\longmapsto g * a := {}^g a := \tilde{g} \cdot a \cdot \tilde{g}^{-1}, \end{aligned}$$

First, we check that $*$ is well-defined, i.e. that this definition is independent of the choice of the preimages: indeed, if $\hat{g} \in E$ is such that $p(\hat{g}) = g$, then, we have

$$p(\tilde{g} \cdot \hat{g}^{-1}) = g \cdot g^{-1} = 1_G$$

hence $\tilde{g} \cdot \hat{g}^{-1} \in \ker(p) = A$, and thus, there exists $a \in A$ such that $\tilde{g} = a\hat{g}$. Therefore, for every $x \in A$,

$$\tilde{g} \cdot x \cdot \tilde{g}^{-1} = \underbrace{a\hat{g}x\hat{g}^{-1}}_{A \trianglelefteq E} a^{-1} = a a^{-1} \hat{g} x \hat{g}^{-1} = \hat{g} x \hat{g}^{-1},$$

where the last-but-one equality holds because A is abelian.

We extend $*$ by \mathbb{Z} -linearity to the whole of $\mathbb{Z}G$, and finally one easily checks that $(A, \cdot, *)$ is a $\mathbb{Z}G$ -module. See Exercise 2, Exercise Sheet 10. ■

Convention: From now on, given a group extension $1 \longrightarrow A \xrightarrow{i} E \xrightarrow{p} G \longrightarrow 1$ with A abelian, we always see A as a $\mathbb{Z}G$ -module via the G -action of the proof of Lemma 17.2. We write $A_* := (A, \cdot, *)$ to indicate that we see A as a $\mathbb{Z}G$ -module in this way.

Lemma 17.3

Let $1 \longrightarrow A \xrightarrow{i} E \xrightarrow{p} G \longrightarrow 1$ be a group extension with A abelian. Then, A is central in E if and only if A_* is trivial as a $\mathbb{Z}G$ -module.

Proof: A_* is a trivial $\mathbb{Z}G$ -module $\iff {}^g a = a \quad \forall a \in A, \forall g \in G \iff \tilde{g} \cdot a \cdot \tilde{g}^{-1} = a \quad \forall a \in A, \forall \tilde{g} \in E$
 $\iff \tilde{g} a = a \tilde{g} \quad \forall a \in A, \forall \tilde{g} \in E$
 $\iff A \subseteq Z(E).$ ■

Definition 17.4 (Central extension)

A group extension $1 \longrightarrow A \xrightarrow{i} E \xrightarrow{p} G \longrightarrow 1$ be a group extension with A abelian satisfying the equivalent conditions of Lemma 17.3 is called a **central extension** of A by G .

Definition 17.5 (Split extension)

A group extension $1 \longrightarrow A \xrightarrow{i} E \xrightarrow{p} G \longrightarrow 1$ **splits** iff there exists a group homomorphism $s : G \longrightarrow E$ such that $p \circ s = \text{Id}_G$. In this case s is called a **(group-theoretic) section** of p , or a **splitting** of the extension.

Proposition 17.6

Let $1 \longrightarrow A \xrightarrow{i} E \xrightarrow{p} G \longrightarrow 1$ be a group extension. Then the following are equivalent:

- (a) The extension splits.
- (b) There exists a subgroup H of E such that $p|_H : H \longrightarrow G$ is an isomorphism.
- (c) There exists a subgroup H of E such that E is the internal semi-direct product of A by H .
- (d) There exists a subgroup H of E such that every element $e \in E$ can be written uniquely $e = ah$ with $a \in A$ and $h \in H$.

Proof:

(a) \Rightarrow (b): By (a) there exists a section $s : G \longrightarrow E$ for p . Define $H := \text{Im } s$. Then $p|_H$ is an isomorphism since, on the one hand $p|_H \circ s = \text{Id}_G$ by definition of s , and on the other hand for every $h \in H$, there exists $g \in G$ such that $h = s(g)$, so that

$$(s \circ p|_H)(h) = (s \circ p)(s(g)) = s(g) = h$$

and $s \circ p|_H = \text{Id}_H$.

(b) \Rightarrow (c): By (b) there is $H \leq E$ such that $p|_H : H \longrightarrow G$ is an isomorphism. Hence

$$\{1\} = \ker(p|_H) = \ker(p) \cap H = A \cap H.$$

Now, let $e \in E$. Then $p(e) \in G \Rightarrow (p|_H)^{-1} \circ p(e) \in H$ and $p(e) = p((p|_H)^{-1} \circ p(e))$, so that

$$e \cdot \left((p|_H)^{-1} \circ p(e) \right)^{-1} \in \ker p = A.$$

Therefore, there exists $a \in A$ such that

$$e = a \cdot \underbrace{\left((p|_H)^{-1} \circ p(e) \right)}_{\in H} \in AH$$

as required.

(c) \Rightarrow (d): Was proven in Step 1 of the proof of Proposition 1.3.

(d) \Rightarrow (b): We have to prove that $p|_H : H \longrightarrow G$ is an isomorphism.

Surjectivity: Let $g \in G$. Then by surjectivity of p there exists $e \in E$ such that $g = p(e)$, and by (d), e can be written in a unique way as $e = ah$ with $a \in A$ and $h \in H$. Hence $p|_H$ is surjective since

$$g = p(e) = p(ah) = p(a)p(h) = 1 \cdot p(h) = p(h).$$

Injectivity: If $h \in H$ is such that $p|_H(h) = 1$, then $h \in \ker(p) = A$, therefore

$$h = 1 \cdot h = h \cdot 1 \in AH$$

so that by uniqueness, we must have $h = 1$ and $\ker(p|_H) = \{1\}$.

(b) \Rightarrow (a): If $p|_H : H \longrightarrow G$ is an isomorphism, then we may define $s := (p|_H)^{-1} : G \longrightarrow E$. This is obviously a group homomorphism and hence a splitting of the extension. ■

If the equivalent conditions of the Proposition are satisfied, then there is a name for the subgroup H , it is called a complement:

Definition 17.7 (Complement of a subgroup)

Let E be a group and A be a normal subgroup of E . A subgroup H of E is called a **complement** of A in E if $E = AH$ and $A \cap H = 1$, i.e. if E is the internal semi-direct product of A by H .

Remark 17.8

Unlike short exact sequences of modules, it is not true that p admits a group-theoretic section if and only if i admits a group-theoretic retraction. In fact, if i admits a group-theoretic retraction, then $E \cong A \times G$. (See Exercise Sheet 10.)

18 H^1 and Group Extensions

In order to understand the connexion between the group extensions of the form

$$1 \longrightarrow A \longrightarrow E \longrightarrow G \longrightarrow 1$$

with abelian kernel and $H^1(G, A_*)$, first we need to investigate the automorphisms of E .

Definition 18.1 (Inner automorphisms, automorphisms inducing the identity)

Let E be a group.

- (a) Given $x \in E$, write $c_x : E \rightarrow E, e \mapsto xex^{-1}$ for the automorphism of E of conjugation by x .
- (b) Set $\text{Inn}(E) := \{\varphi \in \text{Aut}(E) \mid \exists x \in E \text{ with } \varphi = c_x\}$.
- (c) If $A \leq G$, then set $\text{Inn}_A(E) := \{\varphi \in \text{Aut}(E) \mid \exists x \in A \text{ with } \varphi = c_x\}$.
- (d) If $1 \longrightarrow A \xrightarrow{i} E \xrightarrow{p} G \longrightarrow 1$ is a group extension with abelian kernel, then set

$$\text{Aut}_{A,G}(E) := \{\varphi \in \text{Aut}(E) \mid \varphi|_A = \text{Id}_A \text{ and } p \circ \varphi(e) = p(e) \forall e \in E\}.$$

We say that the elements φ of $\text{Aut}_{A,G}(E)$ induce the identity on both A and G .

Recall (e.g. from the *Einführung in die Algebra*-lecture) that: $\text{Inn}(E) \triangleleft \text{Aut}(E)$, as $\varphi \circ c_x \circ \varphi^{-1} = c_{\varphi(x)}$ for every $x \in E$ and every $\varphi \in \text{Aut}(E)$, and the quotient $\text{Aut}(E)/\text{Inn}(E)$ is called the **outer automorphism group** of E . Moreover, $\text{Inn}(E) \cong E/Z(E)$. It is also obvious that $\text{Aut}_{A,G}(E) \leq \text{Aut}(E)$.

Theorem 18.2 (H^1 and automorphisms)

Let $1 \longrightarrow A \xrightarrow{i} E \xrightarrow{p} G \longrightarrow 1$ be a group extension with abelian kernel. Then:

- (a) $H^1(G, A_*) \cong \text{Aut}_{A,G}(E)/\text{Inn}_A(E)$; and
- (b) if, moreover, the extension is a central extension then

$$H^1(G, A_*) \cong \text{Aut}_{A,G}(E).$$

Proof:

(a) **Claim 1:** $\text{Inn}_A(E) \trianglelefteq \text{Aut}_{A,G}(E)$.

Indeed, clearly for each $a \in A$, $c_a|_A = \text{Id}_A$ because A is abelian and, moreover,

$$p \circ c_a(e) = p(aea^{-1}) = p(a)p(ea^{-1}e^{-1})p(e) = p(e)$$

for every $e \in E$, so that $p \circ c_a = p$. Therefore $\text{Inn}_A E \leq \text{Aut}_{A,G}(E)$, and it is a normal subgroup, because

$$\varphi \circ c_a \circ \varphi^{-1} = c_{\varphi(a)} = c_a$$

for every $a \in A$, every $\varphi \in \text{Aut}_{A,G}(E)$ as $\varphi|_A = \text{Id}_A$.

Claim 2: $\text{Aut}_{A,G}(E) \cong Z^1(G, A_*)$.

We aim at defining a group isomorphism

$$\alpha: \text{Aut}_{A,G}(E) \longrightarrow Z^1(G, A_*).$$

- To begin with, we observe that given $\varphi \in \text{Aut}_{A,G}(E)$ and $x \in E$, we can write $\varphi(x) = f(x)x$ for some element $f(x) \in E$. This defines a map (of sets)

$$\begin{aligned} f: E &\longrightarrow E \\ x &\longmapsto \varphi(x)x^{-1}, \end{aligned}$$

such that $\text{Im}(f) \subseteq A = \ker(p)$ because for every $x \in E$,

$$p(f(x)) = p(\varphi(x)x^{-1}) = \underbrace{p(\varphi(x))}_{=p(x)} p(x^{-1}) = 1_G$$

since φ induces the identity on G . Moreover, f is constant on the cosets of E modulo A because

$$f(xa) = \varphi(xa) \cdot (xa)^{-1} = \varphi(x) \cdot \underbrace{\varphi(a)}_{=a} \cdot a^{-1} \cdot x^{-1} = \varphi(x)x^{-1} = f(x).$$

Therefore f induces a map $\bar{f}: G \longrightarrow A, g \mapsto \bar{f}(g) := f(\tilde{g})$ where we may choose \tilde{g} arbitrarily in $p^{-1}(g)$. This is a 1-cocycle since for all $g, h \in G$, we may choose $\tilde{gh} \in p^{-1}(gh)$, $\tilde{g} \in p^{-1}(g)$, and $\tilde{h} \in p^{-1}(h)$ such that $\tilde{gh} = \tilde{g}\tilde{h}$, and hence

$$\begin{aligned} \bar{f}(gh) &= f(\tilde{gh}) = f(\tilde{g}\tilde{h}) = \varphi(\tilde{g}) \cdot \varphi(\tilde{h}) \cdot \tilde{h}^{-1} \cdot \tilde{g}^{-1} \\ &= \varphi(\tilde{g}) \cdot \tilde{g}^{-1} \cdot \tilde{g} \cdot \bar{f}(h) \cdot \tilde{g}^{-1} = \bar{f}(g)^g \bar{f}(h), \end{aligned}$$

which is the 1-cocycle identity in multiplicative notation.

- As a consequence, we set

$$\alpha(\varphi) := (\bar{f}: G \longrightarrow A).$$

To prove that this defines a group homomorphism, let $\varphi_1, \varphi_2 \in \text{Aut}_{A,G}(E)$ and respectively let $\bar{f}_1, \bar{f}_2: G \longrightarrow A$ be the associated 1-cocycles, i.e. $\alpha(\varphi_1) = \bar{f}_1$ and $\alpha(\varphi_2) = \bar{f}_2$. Then

$$\varphi_1(\tilde{g}) = \bar{f}_1(g)\tilde{g}, \quad \varphi_2(\tilde{g}) = \bar{f}_2(g)\tilde{g} \quad \forall g \in G \text{ with } \tilde{g} \in p^{-1}(g),$$

and hence using the fact that A is abelian yields

$$\begin{aligned} \alpha(\varphi_1 \circ \varphi_2)(g) &= (\varphi_1 \circ \varphi_2)(\tilde{g})\tilde{g}^{-1} = \varphi_1(\bar{f}_2(g)\tilde{g})\tilde{g}^{-1} \\ &= \bar{f}_2(g)\varphi_1(\tilde{g})\tilde{g}^{-1} \\ &= \bar{f}_2(g)\bar{f}_1(g)\tilde{g}\tilde{g}^{-1} \\ &= \bar{f}_2(g)\bar{f}_1(g) \\ &= \alpha(\varphi_1)(g) \cdot \alpha(\varphi_2)(g) = (\alpha(\varphi_1) \cdot \alpha(\varphi_2))(g), \end{aligned}$$

as required.

- In order to prove that α is an isomorphism, we define

$$\begin{aligned} \beta: Z^1(G, A_*) &\longrightarrow \text{Aut}_{A,G}(E) \\ c &\longmapsto \beta(c): E \longrightarrow E, \tilde{g} \mapsto c(g)\tilde{g}, \end{aligned}$$

where $g = p(\tilde{g})$.

First, we check that $\beta(c)$ is indeed a group homomorphism: for $\tilde{g}, \tilde{h} \in E$ with the above notation, we have

$$\begin{aligned} \beta(c)(\tilde{g} \cdot \tilde{h}) &= c(gh)\tilde{g}\tilde{h} \stackrel{1\text{-cocycle id.}}{=} c(g) \cdot {}^g c(h) \cdot \tilde{g}\tilde{h} \\ &= c(g)\tilde{g}c(h)\tilde{g}^{-1}\tilde{g}\tilde{h} \\ &= c(g)\tilde{g}c(h)\tilde{h} \\ &= \beta(c)(\tilde{g}) \cdot \beta(c)(\tilde{h}). \end{aligned}$$

Next, if $\tilde{g} \in A = \ker(p)$, then $g = 1_G$ and therefore

$$\beta(c)(\tilde{g}) = c(1) \cdot \tilde{g} = 1 \cdot \tilde{g} = \tilde{g},$$

where we use the fact that a 1-cocycle is always normalised (indeed $c(1_G) = 1_A$, since for $h \in G$, $c(1_G \cdot h) = c(1_G) \cdot ({}^{1_G}c)(h) = c(1_G)c(h)$ by the 1-cocycle identity). Thus we have proved that $\beta(c)|_A = \text{Id}_A$.

Furthermore, since $c(g) \in A = \ker(p)$, $p(c(g)) = 1_G$ and we get

$$(p \circ \beta(c))(\tilde{g}) = p(c(g) \cdot \tilde{g}) = \underbrace{p(c(g))}_{=1_G} \cdot p(\tilde{g}) = p(\tilde{g})$$

and so $p \circ \beta(c) = p$, or in other words $\beta(c)$ induces the identity on G .

Finally, using Exercise 2(c), Exercise Sheet 10, we obtain that any group homomorphism $E \rightarrow E$ inducing the identity on A and on G must be an isomorphism. Therefore, we have proved that $\beta(c) \in \text{Aut}_{A,G}(E)$ for every $c \in Z^1(G, A_*)$.

- It remains to prove that α and β are inverse to each other. Firstly,

$$((\alpha \circ \beta)(c))(g) = \beta(c)(\tilde{g}) \cdot \tilde{g}^{-1} = c(g)\tilde{g}\tilde{g}^{-1} = c(g) \quad \forall g \in G, \forall c \in Z^1(G, A_*),$$

so that $\alpha \circ \beta$ is the identity on $Z^1(G, A_*)$. Secondly,

$$((\beta \circ \alpha)(\varphi))(\tilde{g}) = (\alpha(\varphi))(g) \cdot \tilde{g}^{-1} = \varphi(g)\tilde{g}\tilde{g}^{-1} = \varphi(g) \quad \forall \tilde{g} \in E, \forall \varphi \in \text{Aut}_{A,G}(E),$$

so that $\beta \circ \alpha$ is the identity on $\text{Aut}_{A,G}(E)$.

Claim 3: $\text{Inn}_A(E) \cong B^1(G, A_*)$.

- Let $a \in A$ and $c_a \in \text{Inn}_A(E)$. Then for every $g \in G$,

$$\alpha(c_a)(g) = c_a(\tilde{g}) \cdot \tilde{g}^{-1} = a \cdot \underbrace{\tilde{g} \cdot a^{-1} \cdot \tilde{g}^{-1}}_{\in A \trianglelefteq E} = \tilde{g}a^{-1}\tilde{g}^{-1} \cdot a = {}^g(a^{-1})a = d_1^*(a^{-1})(g)$$

and therefore $\alpha(c_a) \in B^1(G, A_*)$, i.e. $\alpha(\text{Inn}_A(E)) \subseteq B^1(G, A_*)$.

Conversely, if $a \in A$ and $d_1^*(a) \in B^1(G, A_*)$, then $d_1^*(a)(g) = {}^g a \cdot a^{-1}$ and

$$\beta(d_1^*(a))(\tilde{g}) = d_1^*(a)(g) \cdot \tilde{g} = {}^g a \cdot a^{-1} \cdot \tilde{g} = \tilde{g} \cdot a \cdot \underbrace{\tilde{g}^{-1} \cdot a^{-1} \cdot \tilde{g}}_{\in A \trianglelefteq E} = \underbrace{\tilde{g} \cdot \tilde{g}^{-1}}_{=1} a^{-1} \tilde{g} \cdot a = c_{a^{-1}}(\tilde{g}).$$

Hence $\beta(d_1^*(a)) = c_{a^{-1}} \in \text{Inn}_A(E)$, and $\beta(B^1(G, A_*)) \subseteq \text{Inn}_A(E)$. It follows that $\text{Inn}_A(E)$ corresponds to $\text{Aut}_{A,G}(E)$ under the bijection given by α and β , and we obtain

$$H^1(G, A_*) = Z^1(G, A_*)/B^1(G, A_*) \cong \text{Aut}_{A,G}(E)/\text{Inn}_A(E).$$

- (b) If A is a central subgroup of E , then for every $a \in A$ the conjugation automorphism by a is given by $c_a : E \rightarrow E, e \mapsto aea^{-1} = aa^{-1}e = e$, i.e. the identity on E . Thus

$$\text{Inn}_A(E) = \{c_a : E \rightarrow E \mid a \in A\} = \{\text{Id}_E\}$$

and it follows from (a) that

$$H^1(G, A_*) \cong \text{Aut}_{A,G}(E) / \text{Inn}_A(E) = \text{Aut}_{A,G}(E).$$

■

We are now ready to parametrise the splittings of split group extensions with abelian kernel:

Theorem 18.3 (H^1 and splittings)

Let $\mathcal{E}_\bullet := (1 \rightarrow A \xrightarrow{i} E \xrightarrow{p} G \rightarrow 1)$ be a split group extension with abelian kernel. Then the following holds:

- (a) There is a bijection between $H^1(G, A_*)$ and the set \mathcal{S} of A -conjugacy classes of splittings of the given extension.
- (b) There is a bijection between $H^1(G, A_*)$ and the set of E -conjugacy classes of complements of A in E .

Proof:

- (a) Choose a splitting $s_0 : G \rightarrow E$ and define a map

$$\begin{aligned} \alpha : \text{Aut}_{A,G}(E) &\longrightarrow \{\text{splittings of } \mathcal{E}_\bullet\} \\ \varphi &\longmapsto \varphi \circ s_0. \end{aligned}$$

It is obvious that α is well-defined, i.e. that $\varphi \circ s_0$ is a splitting of the extension as $p\varphi s_0 = ps_0 = \text{Id}_G$. Define a second map

$$\begin{aligned} \beta : \{\text{splittings of } \mathcal{E}_\bullet\} &\longrightarrow \text{Aut}_{A,G}(E) \\ s &\longmapsto (\psi_s : E \rightarrow E, as_0(g) \mapsto as(g)), \end{aligned}$$

where by Proposition 17.6 an arbitrary element $x \in E$ can be written in a unique way as $x = as_0(g)$ with $a \in A$ and $g \in G$. We check that β is well-defined. Firstly, ψ_s is a group homomorphism: for every $x_1 = a_1s_0(g_1), x_2 = a_2s_0(g_2) \in E$, we have

$$\begin{aligned} \psi_s(x_1 \cdot x_2) &= \psi_s(a_1s_0(g_1) \cdot a_2s_0(g_2)) = \psi_s(a_1 \cdot {}^{g_1}a_2 \cdot s_0(g_1g_2)) \\ &= a_1 \cdot {}^{g_1}a_2 \cdot s(g_1g_2) \\ &= a_1s(g_1) \cdot a_2s(g_2) \\ &= \psi_s(a_1s_0(g_1)) \cdot \psi_s(a_2s_0(g_2)) = \psi_s(x_1) \cdot \psi_s(x_2). \end{aligned}$$

Secondly, $\psi_s|_A = \text{Id}_A$ by definition. Thirdly, $p\psi_s = p$ since for $x = as_0(g) \in E$, we have

$$(p \circ \psi_s)(x) = (p \circ \psi_s)(as_0(g)) = p(as(g)) = \underbrace{p(a)}_{=1} \cdot \underbrace{p(s(g))}_{=\text{Id}_G(g)} = g = p(as_0(g)).$$

Finally, the fact that ψ_s is an isomorphism follows again from Exercise 2(c), Exercise Sheet 10 because ψ_s induces the identity on both A and G . Whence β is well-defined.

Next, we check that α and β are inverse to each other. On the one hand,

$$(\alpha \circ \beta)(s) = \alpha(\psi_s) = \psi_s \circ s_0 \quad \forall s \in \{\text{splittings of } \mathcal{E}_\bullet\}$$

but for every $g \in G$, $(\psi_s \circ s_0)(g) = \psi_s(1_A \cdot s_0(g)) = 1_G s(g) = s(g)$, hence $\alpha \circ \beta$ is the identity on the set of splittings of \mathcal{E}_\bullet . On the other hand, for every $\varphi \in \text{Aut}_{A,G}(E)$, we have

$$(\beta \circ \alpha)(\varphi) = \beta(\varphi \circ s_0) = \psi_{\varphi \circ s_0}$$

and for each $x = a s_0(g) \in E$ (with $a \in A$ and $g \in G$), we have

$$\psi_{\varphi \circ s_0}(a s_0(g)) = a \cdot (\varphi \circ s_0)(g) \stackrel{\varphi|_A = \text{Id}_A}{=} \varphi(a) \cdot (\varphi \circ s_0)(g) = \varphi(a \cdot s_0(g)),$$

hence $\beta \circ \alpha$ is the identity on $\text{Aut}_{A,G}(E)$.

Therefore,

$$\text{Aut}_{A,G}(E) \begin{array}{c} \xrightarrow{\alpha} \\ \xleftarrow{\beta} \end{array} \{\text{splittings of } \mathcal{E}_\bullet\}$$

are bijections (of sets). Finally, we determine the behaviour of $\text{Inn}_A(E)$ under these bijections. Let $\varphi \in \text{Aut}_{A,G}(E)$ and $c_b \in \text{Inn}_A(E)$ with $b \in A$. Let $\varphi' = c_b \circ \varphi$. Then

$$\alpha(\varphi) = \varphi \circ s_0 \quad \text{and} \quad \alpha(c_b \circ \varphi) = c_b \circ \varphi \circ s_0.$$

Hence a coset modulo $\text{Inn}_A(E)$ is mapped via α to an equivalence class for the action by conjugation of A on splittings

$$\begin{array}{ccc} A \times \{\text{splittings of } \mathcal{E}_\bullet\} & \longrightarrow & \{\text{splittings of } \mathcal{E}_\bullet\} \\ (b, s) & \mapsto & c_b \circ s. \end{array}$$

Thus passing to the quotient (group quotient on the left hand side $\text{Aut}_{A,G}(E)$, and orbits of $\text{Inn}_A(E)$ on the right hand side) yields a bijection

$$\begin{array}{ccc} \text{Aut}_{A,G}(E)/\text{Inn}_A(E) & \xrightarrow{\sim} & \{A\text{-conjugacy classes of splittings of } \mathcal{E}_\bullet\} \\ \uparrow \cong & & \\ \text{(Thm. 18.2)} & & \\ \downarrow & & \\ H^1(G, A_*) & & \end{array}$$

as required.

- (b) By Proposition 17.6, a splitting s of the extension corresponds to a complement $s(G)$ of A in E , and conversely, a complement H of A in E corresponds to a splitting $(p|_H)^{-1} : G \rightarrow H$. Moreover, the A -conjugacy class of H is the same as the E -conjugacy class of H , because every $e \in E$ may be written in a unique way as $e = ah$ with $a \in A$ and $h \in H$ and so $eHe^{-1} = aHa^{-1}$. The claim follows. ■

19 H^2 and Group Extensions

Convention: In this section all group extensions are assumed to have abelian kernel.

Definition 19.1 (Equivalent group extensions)

Two group extensions $1 \rightarrow A \xrightarrow{i} E \xrightarrow{p} G \rightarrow 1$ and $1 \rightarrow A \xrightarrow{i'} E' \xrightarrow{p'} G \rightarrow 1$ with abelian kernels are called **equivalent** if there exists a group homomorphism $\varphi : E \rightarrow E'$ such that the following diagram commutes

$$\begin{array}{ccccccccc} 1 & \longrightarrow & A & \xrightarrow{i} & E & \xrightarrow{p} & G & \longrightarrow & 1 \\ & & \text{Id}_A \downarrow & & \downarrow \varphi & & \downarrow \text{Id}_G & & \\ 1 & \longrightarrow & A & \xrightarrow{i'} & E' & \xrightarrow{p'} & G & \longrightarrow & 1. \end{array}$$

Remark 19.2

- (a) In the context of Definition 19.1, the homomorphism φ is necessarily bijective. However an isomorphism of groups does not induce an equivalence of extensions in general. In other words, the same middle group E can occur in non-equivalent group extensions with the same kernel A , the same quotient G and the same induced $\mathbb{Z}G$ -module structure on A .
- (b) Equivalence of group extensions is an equivalence relation.

Notation: If G is a group and $A_* := (A, \cdot, *)$ is a $\mathbb{Z}G$ -module (which may see simply as an abelian group), then we let $\mathcal{E}(G, A_*)$ denote the set of equivalence classes of group extensions

$$1 \longrightarrow A \xrightarrow{i} E \xrightarrow{p} G \longrightarrow 1$$

inducing the given $\mathbb{Z}G$ -module structure on A .

Theorem 19.3

Let G be a group and let $A_* := (A, \cdot, *)$ be a fixed $\mathbb{Z}G$ -module (written multiplicatively). Then, there is a bijection

$$H^2(G, A_*) \xleftarrow{\sim} \mathcal{E}(G, A_*) .$$

Moreover, the neutral element of $H^2(G, A_*)$ corresponds to the class of the split extension.

Proof: We want to define a bijection $\mathcal{E}(G, A_*) \longrightarrow H^2(G, A_*)$.

- To begin with, fix an extension

$$1 \longrightarrow A \xrightarrow{i} E \xrightarrow{p} G \longrightarrow 1$$

inducing the given action $*$ on A , and we choose a set-theoretic section $s : G \longrightarrow E$ for p , i.e. such that $p \circ s = \text{Id}_G$. Possibly s is not a group homomorphism, but we may write

$$s(g) \cdot s(h) = f(g, h) \cdot s(gh)$$

for some element $f(g, h) \in E$. This defines a map

$$\begin{aligned} f : G \times G &\longrightarrow E \\ (g, h) &\mapsto f(g, h) := s(g) \cdot s(h) \cdot s(gh)^{-1}. \end{aligned}$$

Furthermore, notice that $f(g, h) \in A = \ker(p)$ because

$$p(f(g, h)) = p(s(g)s(h)s(gh)^{-1}) = p(s(g)) \cdot p(s(h)) \cdot p(s(gh))^{-1} = gh h^{-1} g^{-1} = 1_G$$

for every $g, h \in G$. Hence $f \in \text{Hom}_{\text{Set}}(G \times G, A)$, and as a matter of fact, f is a 2-cocycle because:

$$(s(g) \cdot s(h)) \cdot s(k) = f(g, h) \cdot s(gh) \cdot s(k) = f(g, h) \cdot f(gh, k) \cdot s(ghk)$$

and

$$\begin{aligned} s(g) \cdot (s(h) \cdot s(k)) &= s(g) \cdot f(h, k) \cdot s(hk) = s(g) \cdot f(h, k) \cdot s(g)^{-1} \cdot s(g) \cdot s(hk) \\ &= {}^g f(h, k) \cdot f(g, hk) \cdot s(ghk). \end{aligned}$$

Therefore, by associativity in E , we obtain

$$f(g, h) \cdot f(gh, k) = {}^g f(h, k) \cdot f(g, hk),$$

which is precisely the 2-cocycle identity in multiplicative notation.

Now, we note that if we modify s by a 1-cochain $c : G \longrightarrow A$ and define

$$\begin{aligned} s' : G &\longrightarrow E \\ g &\longmapsto s'(g) := c(g) \cdot s(g), \end{aligned}$$

then the corresponding 2-cocycle is given by

$$\begin{aligned} f'(g, h) &= s'(g) \cdot s'(h) \cdot s'(gh)^{-1} \\ &= c(g) \cdot s(g) \cdot c(h) \cdot s(h) \cdot s(gh)^{-1} \cdot c(gh)^{-1} \\ &= c(g) \cdot s(g) \cdot c(h) \cdot s(g)^{-1} s(g) \cdot s(h) \cdot s(gh)^{-1} \cdot c(gh)^{-1} \\ &= c(g) \cdot s(g) \cdot c(h) \cdot s(g^{-1}) \cdot f(g, h) \cdot c(gh)^{-1} \\ &= c(g) \cdot {}^g c(h) \cdot c(gh)^{-1} \cdot f(g, h) \quad \text{as } A \text{ is abelian} \\ &= {}^g c(h) \cdot c(gh)^{-1} \cdot c(g) \cdot f(g, h) \quad \text{as } A \text{ is abelian} \\ &= (d_2^*(c))(g, h) \cdot f(g, h) \quad \forall g, h \in G. \end{aligned}$$

To sum up, we have modified the 2-cocycle f by the 2-coboundary $d_2^*(c)$. Therefore, the cohomology class $[f] := fB^2(G, A_*)$ of f in $H^2(G, A_*)$ is well-defined, depending on the given extension, but does not depend on the choice of the set-theoretic section s . Hence, we may define a map

$$\begin{aligned} \xi : \mathcal{E}(G, A_*) &\longrightarrow H^2(G, A_*) \\ [1 \rightarrow A \xrightarrow{i} E \xrightarrow{p} G \rightarrow 1] &\longmapsto [f]. \end{aligned}$$

· We check that ξ is well-defined. Suppose that we have two equivalent extensions

$$[1 \rightarrow A \xrightarrow{i} E \xrightarrow{p} G \rightarrow 1] = [1 \rightarrow A \xrightarrow{i'} E' \xrightarrow{p'} G \rightarrow 1] \in \mathcal{E}(G, A_*),$$

that is a commutative diagram of the form

$$\begin{array}{ccccccccc} 1 & \longrightarrow & A & \xrightarrow{i} & E & \xrightarrow{p} & G & \longrightarrow & 1 \\ & & \downarrow \text{Id}_A & \circlearrowleft & \downarrow \varphi & \circlearrowleft & \downarrow \text{Id}_G & & \\ 1 & \longrightarrow & A & \xrightarrow{i'} & E' & \xrightarrow{p'} & G & \longrightarrow & 1 \end{array}$$

where φ is an isomorphism of $E \rightarrow E'$. As above, we choose a set-theoretic section $s : G \rightarrow E$ of p , and it follows that $\varphi \circ s$ is a set-theoretic section for p' , since $p' \circ \varphi \circ s = p \circ s = \text{Id}_G$. The corresponding 2-cocycle is given by

$$\begin{aligned} f'(g, h) &= (\varphi \circ s)(g) \cdot (\varphi \circ s)(h) \cdot (\varphi \circ s)(gh)^{-1} = \varphi(s(g) \cdot s(h) \cdot s(gh)^{-1}) \\ &= \varphi(f(g, h)) = f(g, h) \quad \forall g, h \in G \end{aligned}$$

as $\varphi|_A = \text{Id}_A$. Hence ξ is well-defined.

· **Remark:** We may choose $s : G \rightarrow E$ is such that $s(1) = 1$, and the associated 2-cocycle is normalised. Now if we modify s by a normalised 1-cochain $c : G \rightarrow A$ (i.e. such that $c(1) = 1$), then $d_2^*(c)$ is a normalised 2-coboundary. Therefore, we may as well use normalised cocycles/cochains/coboundaries.

· **Surjectivity of ξ :**

Let $\alpha \in H^2(G, A_*)$ and choose a normalised 2-cocycle $f : G \times G \rightarrow A$ such that $\alpha = [f]$. Construct $E_f := A \times G$ (as a set), which we endow with the product

$$(a, g) \cdot (b, h) = (a \cdot {}^g b \cdot f(g, h), g \cdot h) \quad \forall a, b \in A, \forall g, h \in G.$$

Then (E_f, \cdot) is a group whose neutral element is $(1, 1)$. (Exercise, Exercise Sheet 11) Clearly there are group homomorphisms:

$$\begin{aligned} i : A &\longrightarrow E_f, & a &\longmapsto (a, 1), \\ p : E_f &\longrightarrow G, & (a, g) &\longmapsto g \end{aligned}$$

such that $\ker(p) = \text{Im}(i)$, thus we get a group extension

$$1 \longrightarrow A \xrightarrow{i} E_f \xrightarrow{p} G \longrightarrow 1.$$

We need to prove that the cohomology class of the 2-cocycle induced by this extension via the above construction is precisely $[f]$. So consider the set-theoretic section $s : G \longrightarrow E_f, g \mapsto (1, g)$ and compute that for all $g, h \in G$, we have

$$\begin{aligned} s(g) \cdot s(h) \cdot s(gh)^{-1} &= (1, g) \cdot (1, h) \cdot (1, gh)^{-1} \\ &= (1 \cdot {}^g 1 \cdot f(g, h), gh) \cdot ({}^{(gh)^{-1}} f(gh, (gh)^{-1})^{-1}, (gh)^{-1}) \\ &= (f(g, h) {}^{(gh)} ({}^{(gh)^{-1}} f(gh, (gh)^{-1})), (gh)(gh)^{-1}) \\ &= (f(g, h), 1) \end{aligned}$$

as required.

· Injectivity of ξ :

Let

$$\begin{aligned} [1 \longrightarrow A \xrightarrow{i} E \xrightarrow{p} G \longrightarrow 1], \\ [1 \longrightarrow A \xrightarrow{\tilde{i}} \tilde{E} \xrightarrow{\tilde{p}} G \longrightarrow 1] \end{aligned}$$

be two classes of group extensions in $\mathcal{E}(G, A_*)$. Choose, respectively, $s : G \longrightarrow E$ and $\tilde{s} : G \longrightarrow \tilde{E}$ two set-theoretic section with corresponding 2-cocycles f and \tilde{f} respectively. Now, assume that

$$[f] = [\tilde{f}] \in H^2(G, A_*).$$

Then $\tilde{f} = d_2^*(c) \circ f$ for some 1-cochain $c : G \longrightarrow A$. Changing the choice of \tilde{s} by defining $\tilde{\tilde{s}} : G \longrightarrow \tilde{E}, g \mapsto c(g)^{-1} \cdot \tilde{s}(g)$ modifies \tilde{f} into $d_2^*(c)^{-1} \circ \tilde{f}$ by the first part of the proof. But $d_2^*(c)^{-1} \circ \tilde{f} = f$, therefore, we may assume without loss of generality that the two 2-cocycles are the same. Compute the group law in E : each element of E can be written uniquely as $a \cdot s(g)$ for $a \in A$ and $g \in G$ because $s : G \longrightarrow E$ is a section for $p : E \longrightarrow G$. Hence the product is

$$\begin{aligned} as(g) \cdot bs(h) &= as(g)bs(g)^{-1}s(g)s(h) \\ &= a^g bs(g)s(h) \\ &= \underbrace{a^g bf(g, h)}_{\in A} s(gh) \end{aligned}$$

which is exactly the group law in E_f . Hence $E_f \cong E$ (via $(a, g) \mapsto a \cdot s(g)$) as groups, but also as extensions, because the latter isomorphism induces the identity on both A and G . Similarly, we get that $\tilde{E} \cong E_f$, as group extensions. The injectivity of ξ follows.

· Finally notice that the image under ξ of the split extension

$$1 \longrightarrow A \longrightarrow A \rtimes G \longrightarrow G \longrightarrow 1$$

where the action of G on A is given by $*$, and where the first map is the canonical inclusion and the second map the projection onto G , is trivial. This is because we can choose a section $s : G \longrightarrow A \rtimes G, g \mapsto (1, g)$, which is a group homomorphism. Therefore the corresponding 2-cocycle is $f : G \times G \longrightarrow A, (g, h) \mapsto 1$. This proves the 2nd claim. ■

Remark 19.4

- (a) In the above proof, if we choose $s : G \rightarrow E$ such that $s(1) = 1$, then we obtain a normalised 2-cocycle. If we modify $s : G \rightarrow A$ by a 1-cocycle $c : G \rightarrow A$ such that $c(1) = 1$ (a normalized 1-cochain), then dc is a normalized 2-coboundary. So we see that we can use normalized cochains, cocycles and coboundaries throughout.
- (b) If the group A is not abelian, then $H^3(G, Z(A))$ comes into play for the classification of the extensions. This is more involved.

Example 11

For example, if we want to find all 2-groups of order 2^n ($n \geq 3$) with a central subgroup of order 2 and a corresponding dihedral quotient, then we have to classify the *central extensions* of $G := D_{2^{n-1}}$ by $A := C_2$. By Theorem 19.3 the isomorphism classes of central extensions of the form

$$1 \rightarrow C_2 \rightarrow P \rightarrow D_{2^{n-1}} \rightarrow 1.$$

are in bijection with $H^2(G, A_*)$, where A_* is the trivial $\mathbb{Z}G$ -module. Computations yield $H^2(G, A_*) \cong (\mathbb{Z}/2)^3$, hence there are 8 isomorphism classes of such extensions. Since a presentation of $D_{2^{n-1}}$ is $\langle \rho, \sigma \mid \rho^2 = 1 = \sigma^2, (\rho\sigma)^{2^{n-2}} = 1 \rangle$, obviously P admits a presentation of the form

$$\langle r, s, t \mid rt = tr, st = ts, t^2 = 1, r^2 = t^a, s^2 = t^b, (rs)^{2^{n-2}} = t^c \rangle, \quad a, b, c \in \{0, 1\}.$$

Letting a, b, c vary, we obtain the following groups P :

- (i) The case $a = b = c = 0$ gives the direct product $C_2 \times D_{2^{n-1}}$.
- (ii) The case $a = b = 0, c = 1$ gives the dihedral group D_{2^n} .
- (iii) The cases $a = c = 0, b = 1$ and $b = c = 0, a = 1$ give the group $(C_{2^{n-2}} \times C_2) \rtimes C_2$.
- (iv) The cases $a = 0, b = c = 1$ and $b = 0, a = c = 1$ both give the semi-dihedral group SD_{2^n} of order 2^n .
- (v) The case $c = 0, a = b = 1$ gives the group $C_{2^{n-2}} \rtimes C_4$.
- (vi) The case $a = b = c = 1$ gives the generalised quaternion group Q_{2^n} .

If $n \geq 4$, the groups in cases (i)-(vi) are pairwise non-isomorphic. If $n = 3$ the above holds as well, but the groups in (ii) and (iii) are all isomorphic to D_8 , and the groups in (iv) and (v) are all isomorphic to $C_2 \times C_4$.

Throughout this chapter, unless otherwise stated, G denotes a group in multiplicative notation and $H \leq G$ a subgroup of G . The aim of the chapter is to investigate relations between the cohomology of G and the cohomology of H . This can be done using four operations called *restriction*, *transfer* (or *corestriction*), *induction*, and *coinduction*. As our next aim in the lecture is to prove theorems about finite groups using cohomology, we will most of the time work under the mild assumption that H has finite index in G .

References:

- [Bro94] K. S. BROWN, *Cohomology of groups*, Graduate Texts in Mathematics, vol. 87, Springer-Verlag, New York, 1994.
- [Eve91] L. EVENS, *The cohomology of groups*, Oxford Mathematical Monographs, The Clarendon Press, Oxford University Press, New York, 1991.

20 Restriction in Cohomology

Notation 20.1 (*Restriction of $\mathbb{Z}G$ -modules*)

Let M be a $\mathbb{Z}G$ -module. Because $\mathbb{Z}H \subseteq \mathbb{Z}G$ is a subring, by [Exercise 3(a), Exercise Sheet 4] we may restrict the action of $\mathbb{Z}G$ on M to an action of $\mathbb{Z}H$ on M and regard M as a $\mathbb{Z}H$ -module, which we denote by $M \downarrow_H^G$ or $\text{Res}_H^G(M)$. This operation is called the **restriction of M from G to H** . (In other words, restriction just forgets about the elements of $\mathbb{Z}G$ outside $\mathbb{Z}H$.)

Notice that $\text{Res}_H^G : \mathbb{Z}G\text{Mod} \rightarrow \mathbb{Z}H\text{Mod}$ is a covariant functor, which is a special case of a forgetful functor. One can also prove that $M \downarrow_H^G \cong \mathbb{Z}G \otimes_{\mathbb{Z}G} M$, where $\mathbb{Z}G$ is seen as a $(\mathbb{Z}H, \mathbb{Z}G)$ -bimodule.

Definition 20.2 (*Left transversal, right transversal*)

A **left transversal** of H in G is a set $\{g_i\}_{i \in I}$ of representatives of the left cosets of H in G . Thus $G = \coprod_{i \in I} g_i H$. Similarly, a **right transversal** of H in G is a set of representatives of the right cosets of H in G .

We want to investigate how restriction of modules interacts with the cohomology the groups G and H . To this end, first we need to understand restriction of projective resolutions.

Lemma 20.3

Let P be a free (resp. projective) right $\mathbb{Z}G$ -module. Then $P \downarrow_H^G$ is a free (resp. projective) right $\mathbb{Z}H$ -module. (Similarly for left modules.)

Proof: It suffices to prove that $P \downarrow_H^G$ is a free $\mathbb{Z}H$ -module for $P = \mathbb{Z}G$, because an arbitrary free $\mathbb{Z}G$ -module is isomorphic to a direct sum $\bigoplus \mathbb{Z}G$. So, choose a left transversal $\{g_i\}_{i \in I}$ of H in G . Then

$$\mathbb{Z}G = \bigoplus_{i \in I} g_i \mathbb{Z}H$$

and it follows that $\mathbb{Z}G$ is a free right $\mathbb{Z}H$ -module. Now, if P is a projective right $\mathbb{Z}G$ -module, then P is a direct summand of a free $\mathbb{Z}G$ -module by Proposition-Definition 6.7, therefore by the above $P \downarrow_H^G$ is a direct summand of a free $\mathbb{Z}H$ -module, hence is a projective $\mathbb{Z}H$ -module. ■

Remark 20.4 (Restriction in Cohomology)

Let $P_\bullet = (\dots \xrightarrow{d_3} P_2 \xrightarrow{d_2} P_1 \xrightarrow{d_1} P_0)$ be a projective resolution of the trivial $\mathbb{Z}G$ -module \mathbb{Z} and let M be an arbitrary $\mathbb{Z}G$ -module. Then $H^n(G, M)$ is the cohomology of the cochain complex $\text{Hom}_{\mathbb{Z}G}(P_\bullet, M)$. By Lemma 20.3, restricting to H yields a projective resolution

$$\text{Res}_H^G(P_\bullet) = (\dots \xrightarrow{d_3} P_2 \downarrow_H^G \xrightarrow{d_2} P_1 \downarrow_H^G \xrightarrow{d_1} P_0 \downarrow_H^G)$$

of $\mathbb{Z} = \mathbb{Z} \downarrow_H^G$ seen as a $\mathbb{Z}H$ -module. Now, there is an inclusion map of cochain complexes:

$$i_\bullet : \text{Hom}_{\mathbb{Z}G}(P_\bullet, M) \hookrightarrow \text{Hom}_{\mathbb{Z}H}(\text{Res}_H^G(P_\bullet), M \downarrow_H^G)$$

which, by functoriality (i.e. [Exercise 1, Exercise Sheet 5]), induces a homomorphism in cohomology

$$\text{res}_H^G : H^n(G, M) \longrightarrow H^n(H, M \downarrow_H^G).$$

called **restriction** from G to H .

Remark 20.5

- (a) The map res_H^G need not be injective in general.
- (b) If the bar resolution is used to compute cohomology, then on $Z^n(G, M)$, the map res_H^G is given by ordinary restriction of cocycles from G^n to H^n .

21 Transfer in Cohomology

Assume that H has finite index in G , say $r := |G : H|$. Let $\{g_i\}_{1 \leq i \leq r}$ be a finite left transversal for H in G . If L and M are $\mathbb{Z}G$ -modules, then there is a \mathbb{Z} -linear map

$$\begin{aligned} \text{tr}_H^G : \text{Hom}_{\mathbb{Z}H}(L, M) &\longrightarrow \text{Hom}_{\mathbb{Z}G}(L, M) \\ \varphi &\longmapsto \sum_{i=1}^r g_i \varphi g_i^{-1} \end{aligned}$$

where g_i^{-1} denotes the action of $g_i^{-1} \in G$ on L and g_i denotes the action of $g_i \in G$ on M .

Lemma 21.1

The map tr_H^G is well-defined and $\mathbb{Z}G$ -linear.

Proof:

(1) The definition of tr_H^G does not depend on the choice of the transversal:

Assume $\{g'_i\}_{1 \leq i \leq r}$ is another left transversal for H in G and write $g'_i = g_i h_i$ ($1 \leq i \leq r$) for some $h_i \in H$. If $\varphi \in \text{Hom}_{\mathbb{Z}H}(L, M)$ then making use of the $\mathbb{Z}H$ -linearity of φ , we get

$$\sum_{i=1}^r g'_i \varphi(g'_i)^{-1} = \sum_{i=1}^r g_i h_i \varphi h_i^{-1} g_i^{-1} \stackrel{\mathbb{Z}H\text{-lin.}}{=} \sum_{i=1}^r g_i \varphi h_i h_i^{-1} g_i^{-1} = \sum_{i=1}^r g_i \varphi g_i^{-1},$$

as required.

(2) $\mathbb{Z}G$ -linearity:

Let $s \in G$. Then for each $1 \leq i \leq r$, we may write $sg_i = g_{\sigma(i)} h_i$, where $\sigma \in S_r$ is a permutation and $h_i \in H$ (if i and j are such that $\sigma(i) = \sigma(j)$, then we find $g_i = g_j \cdot h_j^{-1} \cdot h_i$ and thus $i = j$, since $\{g_i\}$ is a transversal). Now, let $x \in L$ and compute

$$\begin{aligned} s \cdot (\text{tr}_H^G(\varphi))(x) &= \sum_{i=1}^r sg_i \varphi(g_i^{-1}x) = \sum_{i=1}^r g_{\sigma(i)} h_i \varphi(g_i^{-1}x) = \sum_{i=1}^r g_{\sigma(i)} \varphi(h_i g_i^{-1}x) \\ &= \sum_{i=1}^r g_{\sigma(i)} \varphi(g_{\sigma(i)}^{-1}sx) \\ &= \sum_{i=1}^r g_{\sigma(i)} \varphi g_{\sigma(i)}^{-1}(sx) \\ &= (\text{tr}_H^G(\varphi))(sx), \end{aligned}$$

as required. ■

Assuming (P_\bullet, d_\bullet) is a projective resolution of the trivial $\mathbb{Z}G$ -module \mathbb{Z} , then for each $n \geq 1$, we may consider the diagram

$$\begin{array}{ccc} \text{Hom}_{\mathbb{Z}H}(P_{n-1}, M) & \xrightarrow{\text{tr}_H^G} & \text{Hom}_{\mathbb{Z}G}(P_{n-1}, M) \\ d_n^* \downarrow & & \downarrow d_n^* \\ \text{Hom}_{\mathbb{Z}H}(P_n, M) & \xrightarrow{\text{tr}_H^G} & \text{Hom}_{\mathbb{Z}G}(P_n, M), \end{array}$$

where for $\varphi \in \text{Hom}_{\mathbb{Z}H}(P_{n-1}, M)$ we compute

$$(d_n^* \circ \text{tr}_H^G)(\varphi) = \sum_{i=1}^r d_n^*(g_i \varphi g_i^{-1}) = \sum_{i=1}^r (g_i \varphi g_i^{-1}) \circ d_n \stackrel{\mathbb{Z}G\text{-lin}}{=} \sum_{i=1}^r g_i (\varphi \circ d_n) g_i^{-1} = \text{tr}_H^G(d_n^*(\varphi))$$

since d_n is $\mathbb{Z}G$ -linear. Hence we have proved that

$$\text{tr}_H^G : \text{Hom}_{\mathbb{Z}H}(P_\bullet, M) \longrightarrow \text{Hom}_{\mathbb{Z}G}(P_\bullet, M)$$

is in fact a cochain map, and therefore, for each $n \geq 0$, it induces a homomorphism in cohomology

$$\text{tr}_H^G : H^n(H, M) \longrightarrow H^n(G, M).$$

Definition 21.2 (Transfer)

The map $\text{tr}_H^G : H^n(H, M) \longrightarrow H^n(G, M)$ is called **transfer** from H to G (or the **relative trace map**, or **corestriction**).

Proposition 21.3

Suppose H has finite index in G , say $r := |G : H| < \infty$. Then the composite map

$$\text{tr}_H^G \circ \text{res}_H^G : H^n(G, M) \longrightarrow H^n(G, M)$$

is the multiplication by $|G : H|$ for each $n \geq 0$.

Proof: Let P_\bullet be a projective $\mathbb{Z}G$ -resolution of \mathbb{Z} . For $m \in \mathbb{Z}_{\geq 0}$, the composition

$$\text{Hom}_{\mathbb{Z}G}(P_m, M) \xrightarrow{\text{inc}} \text{Hom}_{\mathbb{Z}H}(P_m, M) \xrightarrow{\text{tr}_H^G} \text{Hom}_{\mathbb{Z}G}(P_m, M)$$

maps $\varphi \in \text{Hom}_{\mathbb{Z}G}(P_m, M)$ to

$$\text{tr}_H^G(\varphi) = \sum_{i=1}^r g_i \varphi g_i^{-1} \stackrel{\mathbb{Z}G\text{-lin.}}{=} \sum_{i=1}^r g_i g_i^{-1} \varphi = \sum_{i=1}^r \varphi = |G : H| \varphi.$$

These are maps of cochain complexes and induce res_H^G and tr_H^G in cohomology. Moreover, multiplication by r induces multiplication by r in cohomology. The claim follows. ■

22 Induction and Coinduction in Cohomology

Definition 22.1 (Induction)

If M is a $\mathbb{Z}H$ -module, we define $\text{Ind}_H^G(M) := \mathbb{Z}G \otimes_{\mathbb{Z}H} M$, the **induction** of M from H to G .

Remark 22.2

$\text{Ind}_H^G(M)$ becomes a $\mathbb{Z}G$ -module via the left $\mathbb{Z}G$ -module structure on $\mathbb{Z}G$. This coincides with the *extension of scalars* we studied in [Exercise 3, Exercise Sheet 4]. Hence we have a universal property for the induction of modules from G to H as follows.

Proposition 22.3 (Universal property of the induction)

Let M be a $\mathbb{Z}H$ -module and let $\iota : M \longrightarrow \text{Ind}_H^G(M), m \mapsto 1 \otimes m$ be the canonical map. Then for every $\mathbb{Z}G$ -module N and for every $\mathbb{Z}H$ -linear map $\varphi : M \longrightarrow \text{Res}_H^G(N)$, there exists a unique $\mathbb{Z}G$ -linear map $\tilde{\varphi} : \text{Ind}_H^G(M) \longrightarrow N$ such that the following diagram commutes:

$$\begin{array}{ccc} M & \xrightarrow{\varphi} & N \\ \downarrow \iota & \nearrow \tilde{\varphi} & \\ \text{Ind}_H^G(M) & & \end{array}$$

In other words, there is an isomorphism of abelian groups

$$\text{Hom}_{\mathbb{Z}H}(M, \text{Res}_H^G(N)) \cong \text{Hom}_{\mathbb{Z}G}(\text{Ind}_H^G(M), N).$$

Proof: This universal property was proven in [Exercise 3(d), Exercise Sheet 4]. ■

Remark 22.4 (Out of the scope of the lecture)

In fact, one can prove that the functor Ind_H^G is left adjoint to the functor Res_H^G .

Definition 22.5 (Coinduction)

If M is a $\mathbb{Z}H$ -module, then we define $\text{Coind}_H^G(M) := \text{Hom}_{\mathbb{Z}H}(\mathbb{Z}G, M)$, the **coinduction**

Remark 22.6

We immediately see that $\text{Coind}_H^G(M)$ becomes a left $\mathbb{Z}G$ -module, using the right $\mathbb{Z}G$ -module structure on $\mathbb{Z}G$. Explicitly, for $g \in G$, $\varphi \in \text{Hom}_{\mathbb{Z}H}(\mathbb{Z}G, M)$ and $x \in \mathbb{Z}G$, we have

$$(g \cdot \varphi)(x) = \varphi(xg).$$

Proposition 22.7 (Universal property of the coinduction)

Let M be a $\mathbb{Z}H$ -module. Let $p : \text{Coind}_H^G(M) \rightarrow M$, $\varphi \mapsto \varphi(1)$ be the canonical evaluation map. Then for every $\mathbb{Z}G$ -module N and every $\mathbb{Z}H$ -linear map $\psi : N \rightarrow M$, there exists a unique $\mathbb{Z}G$ -linear map $\tilde{\psi} : N \rightarrow \text{Coind}_H^G(M)$ such that the following diagram commutes:

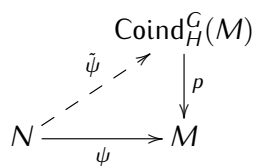

Proof: Exercise. ■

Theorem 22.8 (The Eckmann-Shapiro Lemma)

Let M be a $\mathbb{Z}H$ -module. Then for each $n \in \mathbb{Z}_{\geq 0}$ there are group isomorphisms

$$H_n(G, \text{Ind}_H^G(M)) \cong H_n(H, M) \quad \text{and} \quad H^n(G, \text{Coind}_H^G(M)) \cong H^n(H, M).$$

Proof: Fix $n \in \mathbb{Z}_{\geq 0}$ and let P_\bullet be a projective resolution of \mathbb{Z} as a $\mathbb{Z}G$ -module (hence also as a $\mathbb{Z}H$ -module). Then

$$P_n \otimes_{\mathbb{Z}H} M \cong P_n \otimes_{\mathbb{Z}G} \mathbb{Z}G \otimes_{\mathbb{Z}H} M \cong P_n \otimes_{\mathbb{Z}G} \text{Ind}_H^G(M).$$

Now, the left-hand side gives the homology group $H_n(H, M)$, while the right-hand side gives the homology group $H_n(G, \text{Ind}_H^G(M))$, hence $H_n(G, \text{Ind}_H^G(M)) \cong H_n(H, M)$.

Similarly

$$\text{Hom}_{\mathbb{Z}H}(P_n, M) \cong \text{Hom}_{\mathbb{Z}G}(P_n, \text{Coind}_H^G(M)),$$

where the left-hand side gives the cohomology group $H^n(H, M)$ while the right-hand side gives the cohomology group $H^n(G, \text{Coind}_H^G(M))$. ■

Lemma 22.9

If M is a $\mathbb{Z}H$ -module and H has finite index in G , then $\text{Coind}_H^G(M) \cong \text{Ind}_H^G(M)$.

Proof: Define

$$\begin{aligned}\alpha : \mathbb{Z}G \otimes_{\mathbb{Z}H} M &\longrightarrow \text{Hom}_{\mathbb{Z}H}(\mathbb{Z}G, M) \\ g \otimes m &\longmapsto \varphi_{g,m} : \mathbb{Z}G \longrightarrow M,\end{aligned}$$

where for $s \in G$,

$$\varphi_{g,m}(s) = \begin{cases} sgm & \text{if } sg \in H \\ 0 & \text{if } sg \notin H \end{cases}$$

and we easily check that this is a $\mathbb{Z}G$ -linear map. Now, defining

$$\begin{aligned}\beta : \text{Hom}_{\mathbb{Z}H}(\mathbb{Z}G, M) &\longrightarrow \mathbb{Z}G \otimes_{\mathbb{Z}H} M \\ \psi &\longmapsto \sum_{i=1}^r g_i \otimes \psi(g_i^{-1}),\end{aligned}$$

where $\{g_1, \dots, g_r\}$ is a left transversal of H in G , one easily checks that $\alpha \circ \beta = \text{Id}$ and $\beta \circ \alpha = \text{Id}$. Hence the claim follows. ■

Corollary 22.10

If M is a $\mathbb{Z}H$ -module and H has finite index in G , then $H^n(G, \text{Ind}_H^G(M)) \cong H^n(H, M)$ for each $n \in \mathbb{Z}_{\geq 0}$.

Proof: By the previous lemma $\text{Coind}_H^G(M) \cong \text{Ind}_H^G(M)$. Hence the claim follows from the Eckmann-Shapiro Lemma. ■

The aim of this chapter is to prove several central results of the theory of finite groups: Theorems of Schur and Zassenhaus and Burnside's transfer theorem (also known as Burnside's normal p -complement theorem).

Throughout this chapter, unless otherwise stated, G denotes a **finite** group in multiplicative notation.

References:

- [Bro94] K. S. BROWN, *Cohomology of groups*, Graduate Texts in Mathematics, vol. 87, Springer-Verlag, New York, 1994.
- [Rot09] J. J. ROTMAN, *An introduction to the theory of groups. Fourth ed.*, Graduate Texts in Mathematics, vol. 148, Springer-Verlag, New York, 1995.

23 Cohomology of Finite Groups

To begin with, we collect in this section a few general results about the cohomology of finite groups.

Lemma 23.1

If G is a finite group, then $|G| \cdot H^n(G, M) = 0$ for every $n \geq 1$.

Proof: Let $\mathbb{1}$ denote the trivial group. Because $\mathbb{1}$ is a cyclic group of order one Theorem 16.2 yields $H^n(\mathbb{1}, M) \cong 0$ if $n \geq 1$ (whereas $H^0(\mathbb{1}, M) \cong M$). Now, the composition of the restriction with the transfer

$$H^n(G, M) \xrightarrow{\text{res}_{\mathbb{1}}^G} \underbrace{H^n(\mathbb{1}, M)}_{\cong 0 \text{ if } n \geq 1} \xrightarrow{\text{tr}_{\mathbb{1}}^G} H^n(G, M)$$

equals multiplication by the index of $|G : \mathbb{1}| = |G|$ by Proposition 21.3 and factors through 0 if $n \geq 1$ by the above. Therefore multiplication by $|G|$ is zero in $H^n(G, M)$ if $n \geq 1$. ■

Proposition 23.2

If G is a finite group and M is a finitely generated $\mathbb{Z}G$ -module then $H^0(G, M)$ is a finitely generated abelian group and $H^n(G, M)$ is a finite abelian group of exponent dividing $|G|$ for all $n \geq 1$.

Proof: Fix $n \in \mathbb{Z}_{\geq 0}$.

Claim 1: $H^n(G, M)$ is a finitely generated abelian group.

Indeed: Using the fact that $\mathbb{Z}G$ is a noetherian ring as G is finite, we may construct a projective $\mathbb{Z}G$ -resolution P_\bullet of \mathbb{Z} in which all the modules are finitely generated abelian groups. Now, applying the functor $\text{Hom}_{\mathbb{Z}G}(-, M)$ to P_\bullet we again obtain complexes of finitely generated abelian groups since for each $m \geq 0$, $\text{Hom}_{\mathbb{Z}G}(P_m, M) = \text{Hom}_{\mathbb{Z}}(P_m, M)^G \subseteq \text{Hom}_{\mathbb{Z}}(P_m, M)$, which is a finitely generated abelian group if both P_m and M are. The cohomology groups of this complex is again finitely generated.

Claim 2: $H^n(G, M)$ is a finite group if $n \geq 1$.

Indeed: Since $H^n(G, M)$ is a finitely generated abelian group by the first claim and $|G| \cdot H^n(G, M) = 0$ by Lemma 23.1, $H^n(G, M)$ must be torsion, hence finite. ■

Exercise [Exercise 1, Exercise Sheet 12]

If M is a $\mathbb{Z}G$ -module which is induced from the trivial subgroup, then $H^n(G, M) = 0$ for all $n \geq 1$. Deduce that $H^n(G, M) = 0$ for all $n \geq 1$ if M is a projective $\mathbb{Z}G$ -module.

Exercise [Exercise 2, Exercise Sheet 12]

Let p be a prime number, let G be a finite group of order divisible by p , and let P be a Sylow p -subgroup of G . If M is an $\mathbb{F}_p G$ -module, then the restriction map

$$\text{res}_P^G : H^n(G, M) \longrightarrow H^n(P, \text{Res}_P^G(M))$$

is injective for all $n \geq 0$.

24 The Theorems of Schur and Zassenhaus

In this section we prove two main results of the theory of finite groups, which are often considered as one Theorem and called the *Schur-Zassenhaus Theorem*. Because of the methods we have developed, we differentiate between the abelian and the non-abelian case.

Theorem 24.1 (Schur, 1904)

Let G be a finite group and let $A = (A, \cdot, *)$ be a $\mathbb{Z}G$ -module such that there exists $m \in \mathbb{Z}_{\geq 1}$ with $a^m = 1$ for all $a \in A$. Suppose that $(|G|, m) = 1$. Then the following hold:

- (a) Every group extension $1 \longrightarrow A \xrightarrow{i} E \xrightarrow{p} G \longrightarrow 1$ inducing the given G -action on A splits.
- (b) Any two complements of A in E are E -conjugate.

Proof: We prove that the $H^n(G, A)$ is trivial for all $n \geq 1$. For convenience, write A additively in this proof. Thus by assumption we have $m \cdot A = 0$. By Lemma 23.1, we know that $|G| \cdot H^n(G, A) = 0$ for all $n \geq 1$. Since $m \cdot A = 0$, we also have $m \cdot C^n(G, A) = 0$, and thus $m \cdot H^n(G, A) = 0$. Now, by the Bézout identity there exists $u, v \in \mathbb{Z}$ such that

$$u \cdot |G| + v \cdot m = 1,$$

and hence

$$H^n(G, A) = u \cdot \underbrace{|G| \cdot H^n(G, A)}_{=0} + v \cdot \underbrace{m \cdot H^n(G, A)}_{=0} = 0.$$

Since $H^2(G, A)$ vanishes any extension splits and since $H^1(G, A)$ vanishes all complements of A are E -conjugate, by Theorem 19.3 and Theorem 18.3(b) respectively. ■

Theorem 24.2 (Zassenhaus, 1937)

Let $1 \longrightarrow A \xrightarrow{i} E \xrightarrow{p} G \longrightarrow 1$ be an extension of finite groups (where A is not necessarily abelian). If $(|A|, |G|) = 1$, then the extension splits.

Proof: W.l.o.g. we may assume that $|G| \geq 1$. Then we proceed by induction on the size of A .

- If $|A| = 1$ or $|A|$ is prime, then A is abelian. Moreover, $a^{|A|} = 1$ for all $a \in A$. Thus Schur's Theorem applies and yields the result.
- Suppose now that $|A| \in \mathbb{Z}_{\geq 2} \setminus \mathbb{P}$. Let $q \in \mathbb{P}$ be a prime number dividing $|A|$, let P be a Sylow q -subgroup of A , and set $N := N_E(P)$ for the normaliser of P in E .

Claim 1: $E = AN$.

Indeed, if $e \in E$, then P and ePe^{-1} are Sylow q -subgroups of A , hence A -conjugate, so that there exists $a \in A$ such that $ePe^{-1} = aPa^{-1}$. Thus $(a^{-1}e)P(a^{-1}e)^{-1} = P$, i.e. $a^{-1}e \in N_E(P) = N$, and therefore $e = a(a^{-1}e) \in AN$.

Claim 2: A has a complement in E .

We split the proof of this claim in two cases:

Case 1: $N \neq E$.

In this case, restricting p to N yields the group extension

$$1 \longrightarrow A \cap N \xrightarrow{i} N \xrightarrow{p|_N} G \longrightarrow 1$$

where $A \cap N \subsetneq A$ because $G \cong N/(A \cap N) \cong AN/A = E/A$. Thus, by the induction hypothesis, this extension splits. Hence, by Proposition 17.6, there exists a complement H of $A \cap N$ in N . Since $|H| = |G|$, we have $H \cap A = \{1\}$, and therefore H is a complement of A in E .

Case 2: $N = E$.

Let $Z := Z(P)$ be the centre of P , which is a non-trivial subgroup of P because P is a q -group. Since Z is characteristic in P (i.e. invariant under all automorphisms of P), and since P is normal in N , we deduce that Z is normal in E . Thus, by the universal property of the quotient, p induces a group homomorphism $\bar{p}: E/Z \rightarrow G$, $eZ \rightarrow p(e)$, whose kernel is A/Z . In other words, there is a group extension of the form

$$1 \longrightarrow A/Z \longrightarrow E/Z \longrightarrow G \longrightarrow 1.$$

Now $|Z| \neq 1$ implies that $|A/Z| < |A|$, hence, by the induction hypothesis again, this extension splits. So let F be a complement of A/Z in E/Z . By the Correspondence Theorem, there exists a subgroup $\tilde{F} \leq E$ containing Z such that $F = \tilde{F}/Z$. In other words, there is a group extension

$$1 \longrightarrow Z \longrightarrow \tilde{F} \longrightarrow F \longrightarrow 1.$$

Since $F \cong G$ and $Z \leq P \leq A$, we have $(|Z|, |F|) = 1$ and therefore this extension splits by Schur's Theorem. Thus, there is a complement H of Z in \tilde{F} . But $|H| = |G|$ implies $H \cap A = 1$, so that H is also a complement of A in E . The second claim is proved.

We conclude that the extension splits using Proposition 17.6. ■

Remark 24.3

Notice that both Schur's and Zassenhaus' Theorems can be stated in terms not involving cohomology, but their proofs rely on cohomological methods.

25 Burnside's Transfer Theorem

Throughout this section, we let H be a subgroup of G of index $|G : H| =: r$ and A be a *trivial* $\mathbb{Z}G$ -module. Our first aim is to understand the action of the transfer homomorphism on $H^1(G, A)$. So first recall that $H^1(G, A) = Z^1(G, A) = \text{Hom}_{\text{Grp}}(G, A)$ by Example 10, and hence we see the transfer as a homomorphism

$$\text{tr}_H^G : \text{Hom}_{\text{Grp}}(H, A) \longrightarrow \text{Hom}_{\text{Grp}}(G, A).$$

Lemma 25.1

Let $n \in \mathbb{Z}_{\geq 0}$ and let $\mathbb{Z}G^{n+1}$ be the n -th term of the bar resolution of \mathbb{Z} as a $\mathbb{Z}G$ -module. View it as a projective resolution of \mathbb{Z} as a $\mathbb{Z}F$ -module by restriction. Fix a right transversal $S = \{s_1, \dots, s_r\}$ of H in G . Then the comparison maps between this and the bar resolution of \mathbb{Z} as a $\mathbb{Z}H$ -module are given by the canonical inclusion

$$i_n : \mathbb{Z}H^{n+1} \longrightarrow \mathbb{Z}G^{n+1}$$

and by the map

$$\varphi_n : \begin{array}{ccc} \mathbb{Z}G^{n+1} & \longrightarrow & \mathbb{Z}H^{n+1} \\ (g_0, \dots, g_n) & \mapsto & (h_0, \dots, h_n), \end{array}$$

where, for every $0 \leq i \leq n$, $g_i = h_i s_i$ for some $h_i \in H$ and some $s_i \in S$.

Proof: Using the definition of the differential maps of the bar resolution, we see that there are commutative diagrams

$$\begin{array}{ccc} \mathbb{Z}H^{n+1} & \xrightarrow{i_n} & \mathbb{Z}G^{n+1} \\ \downarrow d_n & \circlearrowleft & \downarrow d_n \\ \mathbb{Z}H^n & \xrightarrow{i_{n-1}} & \mathbb{Z}G^n \end{array} \qquad \begin{array}{ccc} \mathbb{Z}H & \xrightarrow{i_0} & \mathbb{Z}G, \\ \downarrow \varepsilon & \circlearrowleft & \downarrow \varepsilon \\ \mathbb{Z} & \xrightarrow{\text{Id}} & \mathbb{Z} \end{array}$$

and

$$\begin{array}{ccc} \mathbb{Z}G^{n+1} & \xrightarrow{\varphi_n} & \mathbb{Z}H^{n+1} \\ \downarrow d_n & \circlearrowleft & \downarrow d_n \\ \mathbb{Z}G^n & \xrightarrow{\varphi_{n-1}} & \mathbb{Z}H^n \end{array} \qquad \begin{array}{ccc} \mathbb{Z}G & \xrightarrow{\varphi_0} & \mathbb{Z}H, \\ \downarrow \varepsilon & \circlearrowleft & \downarrow \varepsilon \\ \mathbb{Z} & \xrightarrow{\text{Id}} & \mathbb{Z} \end{array}$$

(where $n \geq 1$). Thus the Comparison Theorem yields the result. ■

Proposition 25.2

Fix a right transversal $S = \{s_1, \dots, s_r\}$ of H in G . Then the transfer for H^1 is described as follows:

$$\text{tr}_H^G : \text{Hom}_{\text{Grp}}(H, A) \longrightarrow \text{Hom}_{\text{Grp}}(G, A)$$

$$f \longmapsto \left(\text{tr}_H^G(f) : g \longmapsto \sum_{i=1}^r f(h_i) \right),$$

where $s_i g = h_i s_i$ with $h_i \in H$ for all $1 \leq i \leq r$.

Proof: On the one hand

$$\mathrm{Hom}_{\mathrm{Grp}}(H, A) = H^1(H, A) \cong H^1(\mathrm{Hom}_{\mathbb{Z}H}(\mathbb{Z}H^2, A)),$$

via the bar resolution. On the other hand,

$$\mathrm{Hom}_{\mathrm{Grp}}(H, A) = H^1(H, A) \cong H^1(\mathrm{Hom}_{\mathbb{Z}H}(\mathbb{Z}G^2, A)),$$

via the bar resolution for G restricted to H . Now, transfer is defined using the second resolution, therefore, we need to compare these two resolutions. But

$$H^1(H, A) = Z^1(H, A),$$

because $B^1(H, A) = 0$ since H acts trivially on A , and

$$Z^1(H, A) \subseteq C^1(H, A) \cong \mathrm{Hom}_{\mathbb{Z}H}(\mathbb{Z}H^2, A).$$

If for a given $f \in \mathrm{Hom}_{\mathrm{Grp}}(H, A)$, \tilde{f} denotes the image of f in $\mathrm{Hom}_{\mathbb{Z}H}(\mathbb{Z}H^2, A)$, then for $h \in H$ set

$$\begin{aligned} \tilde{f} : \mathbb{Z}H^2 &\longrightarrow A \\ (1, h) = [h] &\longmapsto f(h) \end{aligned}$$

and thus for each $k \in H$,

$$\tilde{f}((k, kh)) = \tilde{f}(k \cdot (1, h)) = k \cdot f(h) = f(h),$$

because H acts trivially on A , and we extend this map by \mathbb{Z} -linearity to the whole of $\mathbb{Z}H^2$. Using the comparison map $\varphi_1 : \mathbb{Z}G^2 \longrightarrow \mathbb{Z}H^2$ of the previous lemma yields $\tilde{f} \circ \varphi_1 : \mathbb{Z}G^2 \longrightarrow A$, which is $\mathbb{Z}H$ -linear. Now, computing the transfer using its definition yields for every $x \in \mathbb{Z}G^2$:

$$\mathrm{tr}_H^G(\tilde{f} \circ \varphi_1)(x) = \sum_{i=1}^r s_i^{-1}(\tilde{f} \circ \varphi_1)(s_i x) = \sum_{i=1}^r (\tilde{f} \circ \varphi_1)(s_i x)$$

because $\{s_1^{-1}, \dots, s_r^{-1}\}$ is a left transversal of H in G and A is trivial. We want to view this as a 1-cocycle for G , that is evaluate this on an element $[g] = (1, g) \in G^2 \subset \mathbb{Z}G^2$:

$$\mathrm{tr}_H^G(f)(g) = \mathrm{tr}_H^G(\tilde{f} \circ \varphi_1)(1, g) = \sum_{i=1}^r (\tilde{f} \circ \varphi_1)(s_i, s_i g) = \sum_{i=1}^r \tilde{f}(1, h_i)$$

because $s_i = 1 \cdot s_i$ and $s_i g = h_i s_{\sigma(i)}$. So we obtain

$$\mathrm{tr}_H^G(f)(g) = \sum_{i=1}^r \tilde{f}(1, h_i) = \sum_{i=1}^r f(h_i),$$

as required. ■

Lemma 25.3 (Choice of transversal for a fixed $g \in G$)

Fix $g \in G$.

(a) There exists a right transversal of H in G of the form

$$S = \{t_1, t_1 g, \dots, t_1 g^{m_1-1}, t_2, t_2 g, \dots, t_2 g^{m_2-1}, \dots, t_s, t_s g, \dots, t_s g^{m_s-1}\}$$

with $m_1 + \dots + m_s = |G : H| = r$ and $t_i g^{m_i} t_i^{-1} \in H$ for all $1 \leq i \leq s$.

(b) If $f \in \mathrm{Hom}_{\mathrm{Grp}}(H, A)$ and $g \in G$, then $\mathrm{tr}_H^G(f)(g) = \sum_{i=1}^s f(t_i g^{m_i} t_i^{-1})$.

Proof:

- (a) The element g acts on the right on right cosets Hs , via $Hs \mapsto Hsg$. Decompose the set of right cosets into g -orbits. Let r be the number of g -orbits and let Ht_1, \dots, Ht_r be representatives of the g -orbits. We get all the right cosets of H by applying powers of g to each Ht_i and we suppose that $Ht_i g^{m_i-1} = Ht_i$ (that is, m_i is the cardinality of the orbit). With this choice, we obtain a right transversal with the required properties.
- (b) Proposition 25.2 together with (a) yield for $1 \leq i \leq s$:

$$t_i g, t_i g^2, \dots, t_i g^{m_i-1}$$

belong to the right transversal S , so that $(t_i g^k) \cdot g = 1 \cdot (t_i g^{k+1}) \in H \cdot S$ for $0 \leq k \leq m_i - 2$ and $(t_i g^{m_i-1} g) = (t_i g^{m_i} t_i^{-1}) t_i \in H \cdot S$. Therefore

$$\mathrm{tr}_H^G(f)(g) = \sum_{i=1}^s f(t_i g^{m_i} t_i^{-1}),$$

because all the other elements of H appearing are 1 and $f(1) = 0$. ■

Theorem 25.4 (Burnside's transfer theorem (or Burnside's normal p -complement theorem), 1911)

Let G be a finite group, let p be a prime number such that $p \mid |G|$ and let P be a Sylow p -subgroup of G . If P is abelian and $C_G(P) = N_G(P)$, then there exists a normal complement N to P in G , i.e. $G = N \rtimes P$.

Proof:

Claim: If there exist $g \in G$ and $u \in P$ such that $u, gug^{-1} \in P$, then $gug^{-1} = u$.

Indeed: using the assumptions, we have $u \in g^{-1}Pg$, which is abelian, and therefore both P and $g^{-1}Pg$ are Sylow p -subgroups of $C_G(u)$. Thus P and $g^{-1}Pg$ are conjugate in $C_G(u)$, so that there exists $c \in C_G(u)$ such that $cPc^{-1} = g^{-1}Pg$, that is $gcP(gc)^{-1} = P$ and hence $gc \in N_G(P) = C_G(P)$. Finally, $gug^{-1} = (gc)u(gc)^{-1} = u$ because $u \in P$, as required.

Now consider the identity map $\mathrm{Id}_P \in \mathrm{Hom}_{\mathrm{Grp}}(P, P)$ and $\mathrm{tr}_P^G(\mathrm{Id}_P) \in \mathrm{Hom}_{\mathrm{Grp}}(G, P)$. The previous lemma yields for a fixed $u \in P$,

$$\mathrm{tr}_P^G(\mathrm{Id}_P)(u) = \prod_{i=1}^s \mathrm{Id}_P \left(\underbrace{t_i u^{m_i} t_i^{-1}}_{\in P} \right).$$

Now using the claim yields $t_i u^{m_i} t_i^{-1} = u^{m_i}$ for each $1 \leq i \leq s$, hence

$$\mathrm{tr}_P^G(\mathrm{Id}_P)(u) = \prod_{i=1}^s u^{m_i} = u^{|G:P|}.$$

In particular, this proves that $\mathrm{tr}_P^G(\mathrm{Id}_P) : G \rightarrow P$ is a surjective group homomorphism, because for each $v \in P$, there exists $u \in P$ such that $u^{|G:P|} = v$ by the Bézout identity. (Indeed, Bézout implies that there exist $a, b \in \mathbb{Z}$ such that $a|P| + b|G:P| = 1$, hence $v = v^1 = (v^b)^{|G:P|}$ and we choose $u = v^b$.)

Finally, set $N := \ker \left(\mathrm{tr}_P^G(\mathrm{Id}) \right)$, so that we have a group extension

$$1 \longrightarrow N \longrightarrow G \xrightarrow{\mathrm{tr}_P^G(\mathrm{Id}_P)} P \longrightarrow 1$$

with a section given by $\frac{1}{|G:P|} \cdot \iota$, where $\iota : P \rightarrow G$ is the canonical inclusion. It follows that N is a normal complement of P in G . ■

Chapter 9. The Schur Multiplier and Universal Central Extensions

The Schur multiplier is a very important tool of finite group theory and representation theory of finite groups; it can be defined as certain cohomology group associated to a given group G , but as we will immediately see, it can also be defined as a homology group, which point of view makes it a very important tool of algebraic topology as well. We will also show that it has very natural connections with central extensions and projective representations.

Throughout this chapter, unless otherwise stated, G denotes a group in multiplicative notation, K a field and K^\times denotes the multiplicative group of units of K .

References:

- [CR90] C. W. CURTIS AND I. REINER, *Methods of representation theory. Vol. I*, Wiley Classics Library, John Wiley & Sons, Inc., New York, 1990.
- [Rot09] J. J. ROTMAN, *An introduction to the theory of groups. Fourth ed.*, Graduate Texts in Mathematics, vol. 148, Springer-Verlag, New York, 1995.
- [LT17] C. Lassueur and J. Thévenaz, *Universal p' -central extensions*, Expo. Math. 35 (2017), no. 3, 237–251.

26 The Schur Multiplier

Definition 26.1 (*Schur multiplier*)

The **Schur multiplier** (or **multiplicator**) of a group G is the abelian group $M(G) := H^2(G, \mathbb{C}^\times)$, where \mathbb{C}^\times is seen as a trivial $\mathbb{Z}G$ -module.

Remark 26.2 (*Uniquely divisible groups*)

Recall from group theory that:

- An abelian group $(A, +)$ is said to be **uniquely divisible by an integer** $n \in \mathbb{Z}_{\geq 1}$ if for all $a \in A$ there exists a unique $b \in A$ with $a = nb$, or equivalently iff the homomorphism of multiplication by n , i.e. $m_n : A \rightarrow A, b \mapsto nb$ is an isomorphism. For Example, if A is finite and $(|A|, n) = 1$ then A is uniquely divisible by n .
- Moreover, A is said to be **uniquely divisible** if it is uniquely divisible by every positive integer $n \in \mathbb{Z}_{\geq 1}$.
For example, \mathbb{Q} and \mathbb{R} are uniquely divisible; \mathbb{Q}/\mathbb{Z} is not uniquely divisible.

Lemma 26.3

- (a) If G is a finite group and M is a $\mathbb{Z}G$ -module which is uniquely divisible by $|G|$ (i.e. as an abelian group), then $H^n(G, M) \cong 0$ for every $n \geq 1$.
- (b) $H^n(G, \mathbb{C}^\times) \cong H^{n+1}(G, \mathbb{Z}) \cong H^n(G, \mathbb{Q}/\mathbb{Z})$ for all $n \geq 1$.

Proof:

- (a) Let $n \geq 1$ be fixed. Since multiplication by $|G|$, $m_{|G|} : M \rightarrow M, m \mapsto |G|m$, is an isomorphism, so is multiplication by $|G|$, $m_{|G|} : H^n(G, M) \rightarrow H^n(G, M)$ by functoriality of cohomology. But this map is the zero map by Lemma 23.1, hence $H^n(G, M) \cong 0$.
- (b) Recall that polar coordinates induce a group isomorphism $\mathbb{C}^\times \cong \mathbb{R}_{>0}^\times \times \mathbb{S}^1, z \mapsto (|z|, \arg(z))$ and the exponential map $\exp : \mathbb{R} \rightarrow \mathbb{S}^1, t \mapsto e^{2\pi it}$ induce a group homomorphism $\mathbb{R}/\mathbb{Z} \cong \mathbb{S}^1$. Hence there is a group extension

$$1 \longrightarrow \mathbb{Z} \longrightarrow \mathbb{R}_{>0}^\times \times \mathbb{R} \xrightarrow{\text{Id} \times \exp} \underbrace{\mathbb{R}_{>0}^\times \times \mathbb{S}^1}_{\mathbb{C}^\times} \longrightarrow 1 .$$

Because the natural logarithm $\ln : (\mathbb{R}_{>0}^\times, \cdot) \rightarrow (\mathbb{R}, +)$ is a group isomorphism the term in the middle is isomorphic to $\mathbb{R} \times \mathbb{R}$, and hence is uniquely divisible. Now the long exact sequence in cohomology associated to this exact sequence has the form

$$\begin{aligned} \dots \rightarrow \underbrace{H^1(G, \mathbb{R}_{>0}^\times \times \mathbb{R})}_{\cong 0} \rightarrow H^1(G, \mathbb{C}^\times) \rightarrow H^2(G, \mathbb{Z}) \rightarrow \underbrace{H^2(G, \mathbb{R}_{>0}^\times \times \mathbb{R})}_{\cong 0} \rightarrow \dots \\ \dots \rightarrow \underbrace{H^n(G, \mathbb{R}_{>0}^\times \times \mathbb{R})}_{\cong 0} \rightarrow H^n(G, \mathbb{C}^\times) \rightarrow H^{n+1}(G, \mathbb{Z}) \rightarrow \underbrace{H^{n+1}(G, \mathbb{R}_{>0}^\times \times \mathbb{R})}_{\cong 0} \rightarrow \dots \end{aligned}$$

Hence, we conclude that $H^n(G, \mathbb{C}^\times) \cong H^{n+1}(G, \mathbb{Z})$ for each $n \geq 1$.

A similar argument using the s.e.s. $1 \longrightarrow \mathbb{Z} \xrightarrow{\text{inc}} \mathbb{Q} \xrightarrow{\text{can}} \mathbb{Q}/\mathbb{Z} \longrightarrow 1$ yields the isomorphism $H^n(G, \mathbb{Q}/\mathbb{Z}) \cong H^{n+1}(G, \mathbb{Z})$ for all $n \geq 1$. ■

Proposition 26.4 (Alternative descriptions of the Schur multiplier)

If G is a finite group, then $H^2(G, \mathbb{C}^\times) \cong H^2(G, \mathbb{Z}/\mathbb{Q}) \cong H^3(G, \mathbb{Z}) \cong H_2(G, \mathbb{Z})$.

Proof: The first two isomorphisms are given by Lemma 26.3(b). The isomorphism $H^3(G, \mathbb{Z}) \cong H_2(G, \mathbb{Z})$ is a consequence of a result known as *the integral duality theorem* which states that for a finite group G , $H^{n+1}(G, \mathbb{Z}) \cong H_n(G, \mathbb{Z})$ whenever $n \geq 1$. We won't prove it in these notes. ■

27 The Projective Lifting Property and Universal Central Extensions

For this section, we followed faithfully [CR90, §11E].

28 Universal p' -Central Extensions

This section followed [LT17].

This appendix provides a short introduction to some of the basic notions of category theory used in this lecture.

References:

- [McL98] S. Mac Lane, *Categories for the working mathematician*, second ed., Graduate Texts in Mathematics, vol. 5, Springer-Verlag, New York, 1998.
- [Wei94] C. A. Weibel, *An introduction to homological algebra*, Cambridge Studies in Advanced Mathematics, vol. 38, Cambridge University Press, Cambridge, 1994.

A Categories

Definition A.1 (*Category*)

A **category** \mathcal{C} consists of:

- a class $\text{Ob}\mathcal{C}$ of **objects**,
- a set $\text{Hom}_{\mathcal{C}}(A, B)$ of **morphisms** for every ordered pair (A, B) of objects, and
- a **composition function**

$$\begin{array}{ccc} \text{Hom}_{\mathcal{C}}(A, B) \times \text{Hom}_{\mathcal{C}}(B, C) & \longrightarrow & \text{Hom}_{\mathcal{C}}(A, C) \\ (f, g) & \longmapsto & g \circ f \end{array}$$

for each ordered triple (A, B, C) of objects,

satisfying the following axioms:

(C1) Unit axiom: for each object $A \in \text{Ob}\mathcal{C}$, there exists an **identity morphism** $1_A \in \text{Hom}_{\mathcal{C}}(A, A)$ such that for every $f \in \text{Hom}_{\mathcal{C}}(A, B)$ for all $B \in \text{Ob}\mathcal{C}$,

$$f \circ 1_A = f = 1_B \circ f.$$

(C2) Associativity axiom: for every $f \in \text{Hom}_{\mathcal{C}}(A, B)$, $g \in \text{Hom}_{\mathcal{C}}(B, C)$ and $h \in \text{Hom}_{\mathcal{C}}(C, D)$ with $A, B, C, D \in \text{Ob}\mathcal{C}$,

$$h \circ (g \circ f) = (h \circ g) \circ f.$$

Let us start with some remarks and examples to enlighten this definition:

Remark A.2

- (a) $\text{Ob}\mathcal{C}$ need not be a set!
- (b) The only requirement on $\text{Hom}_{\mathcal{C}}(A, B)$ is that it be a set, and it is allowed to be empty.
- (c) It is common to write $f : A \rightarrow B$ or $A \xrightarrow{f} B$ instead of $f \in \text{Hom}_{\mathcal{C}}(A, B)$, and to talk about *arrows* instead of *morphisms*. It is also common to write " $A \in \mathcal{C}$ " instead of " $A \in \text{Ob}\mathcal{C}$ ".
- (d) The identity morphism $1_A \in \text{Hom}_{\mathcal{C}}(A, A)$ is uniquely determined: indeed, if $f_A \in \text{Hom}_{\mathcal{C}}(A, A)$ were a second identity morphism, then we would have $f_A = f_A \circ 1_A = 1_A$.

Example A.3

- (a) $\mathcal{C} = \mathbf{1}$: category with one object and one morphism (the identity morphism):



- (b) $\mathcal{C} = \mathbf{2}$: category with two objects and three morphism, where two of them are identity morphisms and the third one goes from one object to the other:

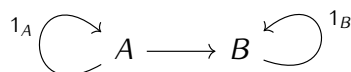

- (c) A group G can be seen as a category $\mathcal{C}(G)$ with one object: $\text{Ob}\mathcal{C}(G) = \{\bullet\}$, $\text{Hom}_{\mathcal{C}(G)}(\bullet, \bullet) = G$ (notice that this is a set) and composition is given by multiplication in the group.
- (d) The $n \times m$ -matrices with entries in a field k for n, m ranging over the positive integers form a category \mathbf{Mat}_k : $\text{Ob}\mathbf{Mat}_k = \mathbb{Z}_{>0}$, morphisms $n \rightarrow m$ from n to m are the $m \times n$ -matrices, and compositions are given by the ordinary matrix multiplication.

Example A.4 (Categories and algebraic structures)

- (a) $\mathcal{C} = \mathbf{Set}$, the *category of sets*: objects are sets, morphisms are maps of sets, and composition is the usual composition of functions.
- (b) $\mathcal{C} = \mathbf{Vec}_k$, the *category of vector spaces over the field k* : objects are k -vector spaces, morphisms are k -linear maps, and composition is the usual composition of functions.
- (c) $\mathcal{C} = \mathbf{Top}$, the *category of topological spaces*: objects are topological spaces, morphisms are continuous maps, and composition is the usual composition of functions.
- (d) $\mathcal{C} = \mathbf{Grp}$, the *category of groups*: objects are groups, morphisms are homomorphisms of groups, and composition is the usual composition of functions.

- (e) $\mathcal{C} = \mathbf{Ab}$, the *category of abelian groups*: objects are abelian groups, morphisms are homomorphisms of groups, and composition is the usual composition of functions.
- (f) $\mathcal{C} = \mathbf{Rng}$, the *category of rings*: objects are rings, morphisms are homomorphisms of rings, and composition is the usual composition of functions.
- (g) $\mathcal{C} = {}_R\mathbf{Mod}$, the *category of left R -modules*: objects are *left* modules over the ring R , morphisms are R -homomorphisms, and composition is the usual composition of functions.
- (g') $\mathcal{C} = \mathbf{Mod}_R$, the *category of right R -modules*: objects are *right* modules over the ring R , morphisms are R -homomorphisms, and composition is the usual composition of functions.
- (g'') $\mathcal{C} = {}_R\mathbf{Mod}_S$, the *category of (R, S) -bimodules*: objects are (R, S) -bimodules over the rings R and S , morphisms are (R, S) -homomorphisms, and composition is the usual composition of functions.
- (h) Examples of your own ...

Definition A.5 (Monomorphism/epimorphism)

Let \mathcal{C} be a category and let $f \in \text{Hom}_{\mathcal{C}}(A, B)$ be a morphism. Then f is called

- (a) a **monomorphism** iff for all morphisms $g_1, g_2 : C \rightarrow A$,

$$f \circ g_1 = f \circ g_2 \implies g_1 = g_2.$$

- (b) an **epimorphism** iff for all morphisms $g_1, g_2 : B \rightarrow C$,

$$g_1 \circ f = g_2 \circ f \implies g_1 = g_2.$$

Remark A.6

In categories, where morphisms are set-theoretic maps, then injective morphisms are monomorphisms, and surjective morphisms are epimorphisms.

In module categories (${}_R\mathbf{Mod}$, \mathbf{Mod}_R , ${}_R\mathbf{Mod}_S$, ...), the converse holds as well, but:

Warning: It is not true in general, that all monomorphisms must be injective, and all epimorphisms must be surjective.

For example in \mathbf{Rng} , the canonical injection $\iota : \mathbb{Z} \rightarrow \mathbb{Q}$ is an epimorphism. Indeed, if C is a ring and $g_1, g_2 \in \text{Hom}_{\mathbf{Rng}}(\mathbb{Q}, C)$

$$\mathbb{Z} \xrightarrow{\iota} \mathbb{Q} \begin{array}{c} \xrightarrow{g_2} \\ \xrightarrow{g_1} \end{array} C$$

are such that $g_1 \circ \iota = g_2 \circ \iota$, then we must have $g_1 = g_2$ by the universal property of the field of fractions. However, ι is clearly not surjective.

B Functors

Definition B.1 (Covariant functor)

Let \mathcal{C} and \mathcal{D} be categories. A **covariant functor** $F : \mathcal{C} \rightarrow \mathcal{D}$ is a collection of maps:

- $F : \text{Ob } \mathcal{C} \longrightarrow \text{Ob } \mathcal{D}, X \mapsto F(X)$, and
 - $F_{A,B} : \text{Hom}_{\mathcal{C}}(A, B) \mapsto \text{Hom}_{\mathcal{D}}(F(A), F(B))$,
- satisfying:
- (a) If $A \xrightarrow{f} B \xrightarrow{g} C$ are morphisms in \mathcal{C} , then $F(g \circ f) = F(g) \circ F(f)$; and
 - (b) $F(1_A) = 1_{F(A)}$ for every $A \in \text{Ob } \mathcal{C}$.

Definition B.2 (Contravariant functor)

- Let \mathcal{C} and \mathcal{D} be categories. A **contravariant functor** $F : \mathcal{C} \longrightarrow \mathcal{D}$ is a collection of maps:
- $F : \text{Ob } \mathcal{C} \longrightarrow \text{Ob } \mathcal{D}, X \mapsto F(X)$, and
 - $F_{A,B} : \text{Hom}_{\mathcal{C}}(A, B) \mapsto \text{Hom}_{\mathcal{D}}(F(B), F(A))$,
- satisfying:
- (a) If $A \xrightarrow{f} B \xrightarrow{g} C$ are morphisms in \mathcal{C} , then $F(g \circ f) = F(f) \circ F(g)$; and
 - (b) $F(1_A) = 1_{F(A)}$ for every $A \in \text{Ob } \mathcal{C}$.

Remark B.3

Often in the literature functors are defined only on objects of categories. When no confusion is to be made and the action of functors on the morphism sets are implicitly obvious, we will also adopt this convention.

Example B.4

Let $Q \in \text{Ob}({}_R\mathbf{Mod})$. Then

$$\text{Hom}_R(Q, -): \begin{array}{ccc} {}_R\mathbf{Mod} & \longrightarrow & \mathbf{Ab} \\ M & \mapsto & \text{Hom}_R(Q, M), \end{array}$$

is a covariant functor, and

$$\text{Hom}_R(-, Q): \begin{array}{ccc} {}_R\mathbf{Mod} & \longrightarrow & \mathbf{Ab} \\ M & \mapsto & \text{Hom}_R(M, Q), \end{array}$$

is a contravariant functor.

Exact Functors.

We are now interested in the relations between functors and exact sequences in categories where it makes sense to define exact sequences, that is categories that behave essentially like module categories such as ${}_R\mathbf{Mod}$. These are the so-called **abelian categories**. It is not the aim, to go into these details, but roughly speaking abelian categories are categories satisfying the following properties:

- they have a zero object (in ${}_R\mathbf{Mod}$: the zero module)

- they have products and coproducts (in $R\mathbf{Mod}$: products and direct sums)
- they have kernels and cokernels (in $R\mathbf{Mod}$: the usual kernels and cokernels of R -linear maps)
- monomorphisms are kernels and epimorphisms are cokernels (in $R\mathbf{Mod}$: satisfied)

Definition B.5 (*Pre-additive categories/additive functors*)

- (a) A category \mathcal{C} in which all sets of morphisms are abelian groups is called **pre-additive**.
- (b) A functor $F : \mathcal{C} \rightarrow \mathcal{D}$ between pre-additive categories is called **additive** iff the maps $F_{A,B}$ are homomorphisms of groups for all $A, B \in \text{Ob } \mathcal{C}$.

Definition B.6 (*Left exact/right exact/exact functors*)

Let $F : \mathcal{C} \rightarrow \mathcal{D}$ be a covariant (resp. contravariant) additive functor between two abelian categories, and let $0 \rightarrow A \xrightarrow{f} B \xrightarrow{g} C \rightarrow 0$ be a s.e.s. of objects and morphisms in \mathcal{C} . Then F is called:

- (a) **left exact** if $0 \rightarrow F(A) \xrightarrow{F(f)} F(B) \xrightarrow{F(g)} F(C)$ (resp. $0 \rightarrow F(C) \xrightarrow{F(g)} F(B) \xrightarrow{F(f)} F(A)$) is an exact sequence.
- (b) **right exact** if $F(A) \xrightarrow{F(f)} F(B) \xrightarrow{F(g)} F(C) \rightarrow 0$ (resp. $F(C) \xrightarrow{F(g)} F(B) \xrightarrow{F(f)} F(A) \rightarrow 0$) is an exact sequence.
- (c) **exact** if $0 \rightarrow F(A) \xrightarrow{F(f)} F(B) \xrightarrow{F(g)} F(C) \rightarrow 0$ (resp. $0 \rightarrow F(C) \xrightarrow{F(g)} F(B) \xrightarrow{F(f)} F(A) \rightarrow 0$) is a short exact sequence.

Example B.7

The functors $\text{Hom}_R(Q, -)$ and $\text{Hom}_R(-, Q)$ of Example B.4 are both left exact functors. Moreover $\text{Hom}_R(Q, -)$ is exact if and only if Q is projective, and $\text{Hom}_R(-, Q)$ is exact if and only if Q is injective.

- [Bro94] K. S. Brown, *Cohomology of groups*, Graduate Texts in Mathematics, vol. 87, Springer-Verlag, New York, 1994, Corrected reprint of the 1982 original.
- [CR90] C. W. Curtis and I. Reiner, *Methods of representation theory. Vol. I*, Wiley Classics Library, John Wiley & Sons, Inc., New York, 1990, With applications to finite groups and orders, Reprint of the 1981 original, A Wiley-Interscience Publication.
- [Eve91] L. Evens, *The cohomology of groups*, Oxford Mathematical Monographs, The Clarendon Press, Oxford University Press, New York, 1991.
- [Hum96] J. F. Humphreys, *A course in group theory*, Oxford Science Publications, The Clarendon Press, Oxford University Press, New York, 1996.
- [Joh90] D. L. Johnson, *Presentations of groups*, London Mathematical Society Student Texts, vol. 15, Cambridge University Press, Cambridge, 1990.
- [LT17] C. Lassueur and J. Thévenaz, *Universal p' -central extensions*, *Expo. Math.* **35** (2017), no. 3, 237–251.
- [ML98] S. Mac Lane, *Categories for the working mathematician*, second ed., Graduate Texts in Mathematics, vol. 5, Springer-Verlag, New York, 1998.
- [Rot95] J. J. Rotman, *An introduction to the theory of groups*, fourth ed., Graduate Texts in Mathematics, vol. 148, Springer-Verlag, New York, 1995.
- [Rot09] Joseph J. Rotman, *An introduction to homological algebra*, second ed., Universitext, Springer, New York, 2009.
- [Rot10] J. J. Rotman, *Advanced modern algebra. 2nd ed.*, Providence, RI: American Mathematical Society (AMS), 2010.
- [Wei94] C. A. Weibel, *An introduction to homological algebra*, Cambridge Studies in Advanced Mathematics, vol. 38, Cambridge University Press, Cambridge, 1994.

General symbols

\mathbb{C}	field of complex numbers
\mathbb{F}_q	finite field with q elements
Id_M	identity map on the set M
$\text{Im}(f)$	image of the map f
$\ker(\varphi)$	kernel of the morphism φ
\mathbb{N}	the natural numbers without 0
\mathbb{N}_0	the natural numbers with 0
\mathbb{P}	the prime numbers in \mathbb{Z}
\mathbb{Q}	field of rational numbers
\mathbb{R}	field of real numbers
\mathbb{Z}	ring of integer numbers
$\mathbb{Z}_{\geq a}, \mathbb{Z}_{>a}, \mathbb{Z}_{\leq a}, \mathbb{Z}_{<a}$	$\{m \in \mathbb{Z} \mid m \geq a \text{ (resp. } m > a, m \leq a, m < a)\}$
$ X $	cardinality of the set X
δ_{ij}	Kronecker's delta
\cup	union
\coprod	disjoint union
\cap	intersection
\sum	summation symbol
\prod, \times	cartesian/direct product
\ltimes	semi-direct product
\oplus	direct sum
\otimes	tensor product
\emptyset	empty set
\forall	for all
\exists	there exists
\cong	isomorphism
$a \mid b, a \nmid b$	a divides b , a does not divide b
(a, b)	gcd of a and b
$f _S$	restriction of the map f to the subset S
\hookrightarrow	injective map
\twoheadrightarrow	surjective map

Group theory

$\text{Aut}(G)$	automorphism group of the group G
$\text{Aut}_{A,G}(E)$	automorphism the group G inducing the identity on A and G
\mathfrak{A}_n	alternating group on n letters
C_m	cyclic group of order m in multiplicative notation
$C_G(x)$	centraliser of the element x in G
$C_G(H)$	centraliser of the subgroup H in G
D_{2n}	dihedral group of order $2n$
$\text{End}(A)$	endomorphism ring of the abelian group A
$\mathcal{E}(G, A_*)$	set of equivalence classes of group extensions
	$1 \longrightarrow A \xrightarrow{i} E \xrightarrow{p} G \longrightarrow 1$ inducing the G -action $*$
G/N	quotient group G modulo N
$\text{GL}_n(K)$	general linear group over K
$\text{PGL}_n(K)$	projective general linear group over K
$H \leq G, H < G$	H is a subgroup of G , resp. a proper subgroup
$N \trianglelefteq G$	N is a normal subgroup G
$N_G(H)$	normaliser of H in G
$N \rtimes_{\theta} H$	semi-direct product of N in H w.r.t. θ
$\text{PGL}_n(K)$	projective linear group over K
Q_8	quaternion group of order 8
Q_{2^n}	generalised quaternion group of order 8
\mathfrak{S}_n	symmetric group on n letters
SD_{2^n}	semi-dihedral group of order 2^n
$\text{SL}_n(K)$	special linear group over K
$\mathbb{Z}/m\mathbb{Z}$	cyclic group of order m in additive notation
xg	conjugate of g by x , i.e. gxg^{-1}
$\langle g \rangle \subseteq G$	subgroup of G generated by g
$G = \langle X \mid R \rangle$	presentation for the group G
$ G : H $	index of the subgroup H in G
$\bar{x} \in G/N$	class of $x \in G$ in the quotient group G/N
$\{1\}, 1, \mathbb{1}$	trivial group

Module theory

$\text{Hom}_R(M, N)$	R -homomorphisms from M to N
$\text{End}_R(M)$	R -endomorphism ring of the R -module M
KG	group algebra of the group G over the ring K
$\varepsilon : KG \longrightarrow K$	augmentation map
IG	augmentation ideal
M^G	G -fixed points of the module M
M_G	G -cofixed points of the module M
$M \downarrow_H^G, \text{Res}_H^G(M)$	restriction of M from G to H
$\text{Ind}_H^G(M)$	induction of M from H to G
res_H^G	restriction from G to H in cohomology
tr_H^G	transfer from H to G

Homological algebra

$B_n(C_\bullet)$	n -boundaries of C_\bullet
$B^n(C^\bullet)$	n -coboundaries of C^\bullet
$B^n(G, A)$	n -coboundaries with coeff. in A rel. to the bar resolution
$(C_\bullet, d_\bullet), C_\bullet$	chain complex
$(C^\bullet, d^\bullet), C^\bullet$	cochain complex
$C^n(G, A)$	n -cochains with coeff. in A rel. to the bar resolution
$\text{Ext}_R^n(M, N)$	n -th Ext-group of M with coefficients in N
$H_n(C_\bullet)$	n -th homology group/module of C_\bullet
$H_n(G, M)$	n -th homology group of the group G with coeff. in M
$H^n(C^\bullet)$	n -th cohomology group/module of C^\bullet
$H^n(G, M)$	n -th cohomology group of the group G with coeff. in M
$P_\bullet \rightarrow M$	projective resolution of the module M
$\text{Tor}_n^R(M, N)$	n -th Tor-group of M with coefficients in N
$Z_n(C_\bullet)$	n -cycles of C_\bullet
$Z^n(C^\bullet)$	n -cocycles of C^\bullet
$Z^n(G, A)$	n -cocycles with coeff. in A rel. to the bar resolution
$[g_1 g_2 \dots g_n]$	bar notation

Category Theory

$\text{Ob } \mathcal{C}$	objects of the category \mathcal{C}
$\text{Hom}_{\mathcal{C}}(A, B)$	morphisms from A to B
Set	the category of sets
Vec$_k$	the category of vector spaces over the field k
Top	the category of topological spaces
Grp	the category of groups
Ab	the category of abelian groups
Rng	the category of rings
${}_R\text{Mod}$	the category of left R -modules
Mod_R	the category of right R -modules
${}_R\text{Mod}_S$	the category of (R, S) -bimodules

- G -cofixed points, 50
- G -fixed points, 50
- n -boundary, 33
- n -coboundary, 36, 56
- n -cochain, 56
- n -cocycle, 36, 56
- n -cycle, 33
- n -th cohomology group, 36, 51
- n -th homology group, 33, 51
- action
 - conjugation, 49
 - diagonal, 49
- arrow, 89
- augmentation
 - ideal, 49
 - map, 49
- axiom
 - associativity axiom, 88
 - unit axiom, 88
- basis
 - of a free group, 10
 - of a module, 25
- bimodule, 17
- category
 - abelian, 91
 - homotopy category, 36
 - of abelian groups, 90
 - of bimodules, 90
 - of groups, 89
 - of left modules, 90
 - of right modules, 90
 - of rings, 90
- of sets, 89
- of topological spaces, 89
- of vector spaces, 89
- pre-additive, 92
- coimage, 20
- coinduction, 78
- cokernel
 - of a morphism, 20
 - of a morphism of complexes, 32
- complement, 65
- complex
 - acyclic, 35
 - augmented, 37
 - chain, 31
 - cochain, 36
 - exact, 35
 - non-negative, 31
 - positive, 31
 - quotient complex, 32
 - zero complex, 34
- composition function, 88
- composition law
 - external, 17
- connecting homomorphism, 23, 34
- corestriction, 76
- degree, 31
- derivation
 - inner, 58
 - principal, 58
- dimension shifting, 44
- direct sum
 - external, 21
 - internal, 21

- epimorphism, 90
- exact sequence, 22
 - short, 22
 - split s.e.s., 24
- Ext-group, 41
- extension
 - central, 63
 - equivalent, 69
 - split, 63
 - universal p' -extension, 87
- functor
 - additive, 92
 - contravariant, 91
 - covariant, 90
 - exact, 92
 - left exact, 92
 - right exact, 92
- generating set, 25
- group
 - extension, 62
 - finitely presented, 13
 - free, 10
 - presentation, 13
 - uniquely divisible, 86
- group algebra, 48
- group ring, 48
- homotopy equivalence, 35
- identity
 - 1-cocycle, 58
 - 2-cocycle, 58
- image
 - of a morphism, 18
 - of a morphism of complexes, 32
- induction
 - of a module, 77
- kernel
 - of a morphism, 18
 - of a morphism of complexes, 32
 - of an extension, 63
- lemma
 - Eckmann-Shapiro lemma, 78
 - horseshoe lemma, 40
 - snake lemma, 23
- long exact sequence
 - in cohomology, 37, 51
 - in homology, 34, 51
- map
 - R -balanced, 28
 - chain map, 32
 - cochain map, 36
 - differential map, 31
 - relative trace, 76
- module
 - flat, 30
 - free, 25
 - homomorphism, 18
 - injective, 27
 - left, 17
 - projective, 27
 - right, 17
 - trivial, 49
- monomorphism, 90
- morphism
 - identity morphism, 88
 - in a category, 88
 - of chain complexes, 32
 - of cochain complexes, 36
- object, 88
- projective lifting property, 87
- quasi-homomorphism, 35
- rank
 - of a free group, 10
- relation, 13
- representation, 49
- resolution
 - bar, 54
 - free, 37
 - injective, 40
 - normalised bar, 55
 - projective, 37
- restriction
 - in cohomology, 75
 - of a module, 74
- retraction, 24
- scalar multiplication, 17
- Schur multiplier, 86

- section, 24
- semi-direct product
 - external, 9
 - internal, 7
- subcomplex, 32
- submodule, 18

- tensor product
 - of modules, 28
 - of morphisms, 29
- theorem
 - 1st isomorphism theorem, 19
 - 2nd isomorphism theorem, 19
 - 3rd isomorphism theorem, 19
 - lifting theorem, 38
 - Burnside's normal p -complement theorem, 85
 - Burnside's transfer theorem, 85
 - comparison theorem, 39
 - correspondence theorem, 20
 - Schur, 81
 - Zassenhaus, 82
- Tor-group, 47
- transfer, 76
- transversal, 74

- universal property
 - of free groups, 10
 - of free modules, 25
 - of presentations, 14
 - of the coinduction, 78
 - of the direct sum, 21
 - of the induction, 77
 - of the product, 20
 - of the quotient, 19
 - of the tensor product, 28

- word, 12
 - equivalent, 13
 - length of, 13
 - reduced, 13